



# Service Manual Gas Electric Refrigerators

**Polar 7 Series (N7V, N7X, N7LX) Models**

**Polar 8 Series (N8V, N8X, N8LX) Models**

Improper installation, adjustment, alteration, service or maintenance can cause personal injury or property damage. Refer to this manual. For assistance or additional information, contact a qualified installer, service agency, or the gas supplier.

**Questions? 1-800-444-7210**

# CONTENTS

<b>SAFETY</b> .....	<b>4</b>
<b>INTRODUCTION</b> .....	<b>5</b>
About this Manual .....	5
Certification and Code Requirements .....	5
About Installation .....	5
Replacement Parts .....	5
Technical Assistance .....	5
Model Identification .....	6
Cooling Unit Serial Number .....	6
Refrigerator Model Number .....	6
<b>SPECIFICATIONS</b> .....	<b>7</b>
Exploded Views .....	8
<b>GENERAL INFORMATION</b> .....	<b>10</b>
Ventilation .....	10
Overview .....	10
Enclosure .....	10
Baffles .....	10
Lower Intake Vent .....	10
Exhaust Vent .....	10
Roof Cap .....	10
Propane Gas Connections .....	11
Leak Test-Detergent .....	11
Electrical Connections .....	11
120 Volts AC Electrical Connection .....	11
12 Volts DC Electrical Connection .....	11
Main Control Board (Power Board) Fuses .....	12
Electrical Components .....	12
Interior Light .....	12
Divider Heater .....	12
12 Volt DC Fan .....	12
Low Ambient Heater (optional) .....	12
Temperature Control System .....	13
Backup Operating System .....	13
<b>PREVENTATIVE MAINTENANCE</b> .....	<b>13</b>
Gas Flame Appearance .....	13
Clean the Openings of the Burner Tube .....	14
<b>USER INTERFACE (CONTROLS) - N7V AND N8V MODELS</b> .	<b>15</b>
Power ON / OFF Button .....	15
Modes of Operation .....	15
Air in the Propane Gas Supply Lines .....	16
Refrigerator Temperature Settings .....	16
Diagnostic Prechecks .....	16
<b>FAULT CODES - N7V AND N8V MODELS</b> .....	<b>17</b>
Fault Code Flash Patterns - N7V and N8V Models .....	17

## TROUBLESHOOTING FLOWCHARTS - N7V AND N8V MODELS

<b>18</b>	
Fault - Code - Solid Red Indicator Light .....	18
Fault Code - Flash Pattern 1 .....	20
Fault Code - Flash Pattern 2 .....	21
Fault Code - Flash Pattern 3 .....	21
Fault Code - Flash Pattern 4 .....	21
Fault Code - Flash Pattern 5 .....	22
Fault Code - Flash Pattern 8 .....	22
Fault Code - Flash Pattern 9 .....	22
Fault Code - Flash Pattern 10 .....	23
Fault Code - Thermistor Fault .....	24
Blank Display .....	25

## USER INTERFACE (CONTROLS) - N7X AND N8X MODELS .

Power ON / OFF Button .....	26
Mode Button .....	26
Temperature Set Button .....	26
Temperature Setting Indicators .....	26
Gas Mode Operation .....	26
AC Mode Operation .....	26
Air in the Propane Gas Supply Lines .....	27
Diagnostic Prechecks .....	27

## FAULT CODES - N7X AND N8X MODELS .....

Fault Code Flash Patterns - N7X and N8X Models .....	27
Fault Code - Flash Patterns .....	28

## TROUBLESHOOTING FLOWCHARTS - N7X AND N8X MODELS

<b>29</b>	
Fault Code - Solid Red Indicator Light .....	29
Fault Code - Flash Pattern 1 .....	31
Fault Code - Flash Pattern 2 .....	32
Fault Code - Flash Pattern 3 .....	32
Fault Code - Flash Pattern 4 .....	32
Fault Code - Flash Pattern 5 .....	33
Fault Code - Flash Pattern 8 .....	33
Fault Code - Flash Pattern 9 .....	33
Fault Code - Flash Pattern 10 .....	34
Fault Code - Thermistor Fault .....	35
Blank Display .....	36

## USER INTERFACE (CONTROLS) - N7LX AND N8LX MODELS

Power ON / OFF Button .....	37
Mode Button .....	37
Temperature Set Button .....	37
Gas Operation .....	37
Gas Mode .....	38
AC Mode .....	38
DC Mode (3-way models only) .....	38
Air in the Propane Gas Supply Lines .....	38
Diagnostic Pre checks .....	38

## FAULT CODES - N7LX AND N8LX MODELS .....

**TROUBLESHOOTING FLOWCHARTS - N7LX AND N8LX**

**MODELS ..... 40**  
Fault Code - “no” “FL” with audible alarm ..... 40  
Fault Code - “no” “AC” with audible alarm ..... 42  
Fault Code - “AC” “HE” with audible alarm ..... 43  
Fault Code - “dc” “HE” with audible alarm ..... 44  
Fault Code - “AC” “rE” with audible alarm ..... 44  
Fault Code - “dc” “rE” with audible alarm ..... 44  
Fault Code - “Lo” “dc” ..... 45  
Fault Code - “Lo” “dc” with audible alarm ..... 45  
Fault Code - “Lo” “dC” with audible alarm ..... 45  
Fault Code - “HI” “dc” with audible alarm ..... 45  
Fault Code - “no” “dt” with audible alarm ..... 46  
Fault Code - “Sr” with audible alarm ..... 47  
Fault Code - “oP” “L” with audible alarm ..... 47  
Fault Code - “FL” “-” with audible alarm ..... 47  
Fault Code - Flashing Temperature Setting ..... 48  
Blank Display ..... 49

**DIAGNOSTIC MODE - N7LX AND N8LX MODELS ..... 50**  
General Diagnostic Information ..... 50  
Access Diagnostic Mode ..... 50  
Change Screens ..... 50  
Exit Diagnostic Mode ..... 50  
Screens and Diagnostic Segments Information ..... 50  
SCREEN 1: All Diagnostic Icons ON ..... 50  
SCREEN 2: All Diagnostic Icons OFF ..... 50  
SCREEN 3: Fresh Food Fin Temperature ..... 50  
SCREEN 4: Stored Fault History ..... 51  
SCREEN 5: Stored Fault History ..... 51  
SCREEN 6: Erasing Fault History ..... 51  
SCREEN 7: Power Board Inputs ..... 51  
SCREEN 8: Power Board Outputs ..... 52  
SCREEN 9: Power Board DC Input Voltage Status ..... 52  
SCREEN 0: Power Board AC Input Voltage Status ..... 52  
SCREEN A ..... 52  
SCREEN B ..... 52  
Cooling System Diagnostic Flowchart ..... 53

**WIRING SCHEMATIC ..... 55**  
ICE MAKER\* ..... 55

**WIRING PICTORIAL ..... 56**

**AUXILIARY WIRING CIRCUITS ..... 57**  
Fan Only ..... 57  
Cold Weather Heater Only ..... 57  
Fan and Cold Weather Heater ..... 58  
Ice Maker Only ..... 58  
Ice Maker and Fan ..... 59  
Ice Maker, Fan, and Cold Weather Heater ..... 59

**ICE MAKER ..... 60**

**REMOVE / REPLACE THE REFRIGERATOR ..... 60**  
Remove the Refrigerator ..... 60  
Replace the Refrigerator ..... 60  
Conduct Leak Test ..... 60

**Figures**

Fig. 1 - Double-wrenching gas fittings ..... 5  
Fig. 2 - Cooling unit bar code label location ..... 6  
Fig. 3 - Refrigerator information label location ..... 6  
Fig. 4 - Exploded front view ..... 8  
Fig. 5 - Exploded rear view ..... 9  
Fig. 6 - Typical roof exhaust venting ..... 11  
Fig. 7 - Fuse locations ..... 12  
Fig. 8 - Fan wiring ..... 12  
Fig. 9 - Burner tube location ..... 14  
Fig. 10 - Openings of the burner tube ..... 14  
Fig. 11 - N7V and N8V user interface (control) locations ..... 15  
Fig. 12 - Change mode and temperature setting ..... 15  
Fig. 13 - Example fault code flash pattern ..... 17  
Fig. 14 - N7X and N8X user interface (control) locations ..... 26  
Fig. 15 - N7LX and N8LX user interface (control) locations ..... 37  
Fig. 16 - Wiring diagram ..... 55  
Fig. 17 - Wiring pictorial ..... 56  
Fig. 18 - Fan only wiring ..... 57  
Fig. 19 - Cold weather heater only wiring ..... 57  
Fig. 20 - Fan and cold weather heater wiring ..... 58  
Fig. 21 - Ice maker only wiring ..... 58  
Fig. 22 - Ice maker and fan wiring ..... 59  
Fig. 23 - Ice maker, fan, and cold weather heater wiring ..... 59

# SAFETY

It is not possible to anticipate all of the conceivable ways or conditions under which the refrigerator may be serviced or to provide cautions as to all of the possible hazards that may result. Standard and accepted safety precautions and equipment should be used when working on electrical circuits and handling toxic or flammable materials. Safety goggles and other required protection should be used during any process that can cause material removal, such as when removing a leaking cooling unit and cleaning components.

Read this manual carefully and understand the contents before working on the refrigerator. Be aware of possible safety hazards when you see the safety alert symbol on the refrigerator and in this manual. A signal word follows the safety alert symbol and identifies the danger of the hazard. Carefully read the descriptions of these signal words to fully know their meanings. They are for your safety.



This signal word means a hazard, which if ignored, can cause small personal injury or much property damage.



This signal word means a hazard, which if ignored, can cause dangerous personal injury, death.

Norcold refrigerators are designed and equipped for the use of propane gas only. Do not modify, alter, or equip the refrigerator to any other fuel (natural gas, butane, etc.).

Incorrect installation, adjustment, alteration, or maintenance of the refrigerator can cause personal injury, property damage, or both.

Do not smoke, light fires, or create sparks when working on propane gas system.

Propane gas is highly flammable and explosive. Do not use an open flame for leak testing any of propane gas system components.

Always use two wrenches to tighten or loosen propane gas connections. Damaged connections, piping, and components create the potential for gas leaks.

All electrical connections and repairs to the refrigerator must comply with all applicable codes. Refer to the "Certification and Code Requirements" section of the Installation Manual.

Turn off AC power and DC power sources before attempting to remove, service, or repair any of the refrigerator's electrical or electronic components. Do not work on live electrical circuits.

Do not modify, bypass, or eliminate any of the refrigerator's electrical components, electronic circuits, or propane gas system components.

Do not wet or spray liquids on or near electrical outlets, connections or components. Most liquids, including leak detection solutions, are electrically conductive and pose the potential for an electric shock hazard, short electrical components, damage electronic circuits, and/or ignite a fire.

Do not use leak test solutions that contain ammonia or chlorine. Ammonia and chlorine degrade copper and brass components.

The cooling unit is a sealed system under pressure! Do not try to repair or recharge the cooling unit. Do not bend, drop, weld, drill, puncture, saw, or strike the cooling unit.

Handle a leaking cooling unit with extreme caution! The cooling unit contains ammonia, hydrogen, and sodium chromate. Ammonia can cause severe skin and eye burns. Hydrogen is highly flammable, can ignite and burns with an intense flame. Certain chromium compounds, such as sodium chromate, are carcinogenic.

Do not use extension cords. Do not remove the grounding prong from the refrigerator AC power cord. Do not use a two prong adapter to connect the refrigerator to the AC outlet.

Do not over-fuse electrical circuits. Use specified fuses and AWG wire sizes. The specification section of this manual provides fuse size information. Refer to the Installation Manual for the correct AWG wire size specifications.

Prevent child entrapment! Before disposing of the refrigerator, remove all doors and fasten all shelves with retainers.

Make sure all hardware such as hinges and fasteners (retaining screws, etc.), are properly fastened.

Obey the instructions in this manual with regard to intake and exhaust venting specifications.

Do not install the refrigerator directly on carpet. Put the refrigerator on a metal or wood panel that extends the full width and depth of the refrigerator.





Some of the refrigerator's metal components have sharp corners and edges. Wear hand protection, such as cut resistant gloves, and exercise extreme care when handling the refrigerator.

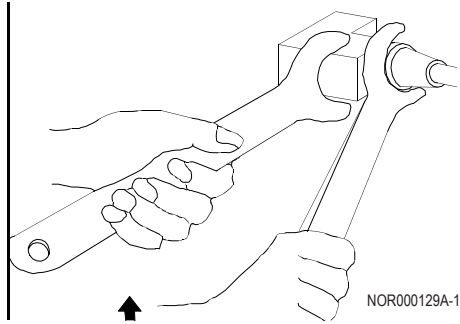

Fig. 1 - Double-wrenching gas fittings

## INTRODUCTION

### About this Manual

This service manual provides maintenance, diagnostic, and repair information for **NORCOLD**® N7V, N7X, N7LX, N8V, N8X, and N8LX Series gas absorption refrigerators. It is a reference tool designed for technicians who are knowledgeable in the theory and operation of gas/electric absorption refrigerators, liquefied petroleum (LP) gas-propane-systems, and AC/DC electrical systems as installed in a variety of recreational vehicles (RV).

All information, illustrations, and specifications contained in this publication are based on the latest product information available at the time of publication. **NORCOLD**® reserves the right to make changes at any time without notice.

### Certification and Code Requirements

**NORCOLD**® gas/electric absorption refrigerators are certified under the latest edition of *ANSI Z21.19B* standards for installation in mobile homes or recreational vehicles, and with the Canadian Standards Association *CAN/CGA-1.4-M94*.

Electrical components are compliant.

### About Installation

Refrigerator installation must conform with the N7V, N7X, N7LX, N8V, N8X, and N8LX Series *Installation Manual* for the **NORCOLD**® limited warranty to be in effect. Installation must also comply with applicable local codes and standards set by the relevant certification agency.

### Replacement Parts

Use only authorized **NORCOLD**® replacement parts. Generic parts do not meet **NORCOLD**® specifications for safety, reliability, and performance. The use of unauthorized aftermarket or generic replacement parts voids the refrigerator's limited warranty coverage.

### Technical Assistance

If unable to resolve technical issues using the information provided in this manual, technical support is available through **NORCOLD**® Customer Service Center:

	Telephone:	1-800-444-7210
	Fax:	1-734-769-2332
	World Wide Web:	www.norcold.com.

The following information is required to process technical support requests:

- Refrigerator Model Number
- Refrigerator Serial Number
- Refrigerator Cooling Unit Serial Number
- Recreational Vehicle (RV) Make/Model/Year

## Model Identification

Models which include .3 in the model number are 3-way refrigerators that operate on AC power, propane gas, or DC power.

Models which DO NOT include .3 in the model number are 2-way refrigerators that operate on AC power or propane gas.

Letter(s) appended to the model number identify factory installed accessories.

## Cooling Unit Serial Number

The cooling unit serial number appears on the cooling unit bar code label. The label is affixed to the surface of the cooling unit leveling chamber.

**NOTICE** Be sure to have the cooling unit serial number available if you need technical support on this component

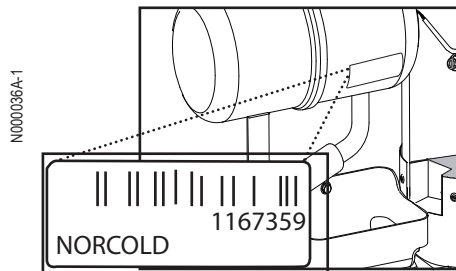

Fig. 2 - Cooling unit bar code label location.

## Refrigerator Model Number

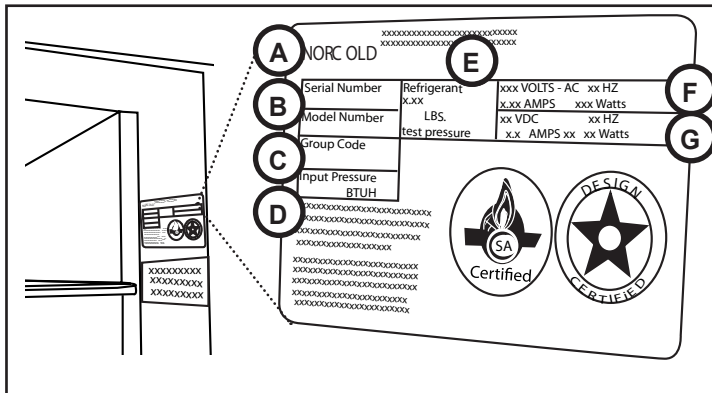

Fig. 3 - Refrigerator information label location

A	Serial Number
B	Model Number
C	Group Code
D	BTU / h
E	Amount of refrigerant in cooling system
F	AC Voltage / Amperage
G	DC Voltage / Amperage

# SPECIFICATIONS

## N7V, N8V Models - Electronic

- Capacitive Touch - ON/OFF
- Single LED Indicator Light (Multi-Color)
- Self-Diagnostic with Fault Indicators (LED Flash Pattern)
- 2-Way Automatic Operation
- Non-Settable Factory Preset Temperature Setting (With Backup Operating System)

## N7X, N8X Models - Electronic

- Capacitive Touch - ON/OFF, Mode, and Temperature Set
- Multiple LED Indicator Lights
- Self-Diagnostic with Fault Indicators (LED Flash Pattern)
- 2-Way Automatic or Manual Operation
- Five (5) Separate Temperature Settings (With Backup Operating System Mode)
- Sleep Mode

## N7LX, N8LX Models - Electronic

- Capacitive Touch - ON/OFF, Mode, and Temperature Set
- Backlit LCD Display with Icon, Numerical, and Text Indicators
- Self-Diagnostic with Fault Codes
- 2-Way Automatic or Manual Operation (Standard), 3-Way Automatic or Manual Operation (Optional)
- Nine (9) Separate Temperature Settings (With Backup Operating System Mode)
- Sleep Mode
- 12 Individual Diagnostic Screens

## Rough Opening Dimensions (H x W x D)

N7V, N7X, N7LX models	52.88 - 53.01 in. x 23.50 - 23.63 x 24.00 - 24.13 in.
N8V, N8X, N8LX models	59.88 - 60.01 in. x 23.50 - 23.63 x 24.00 - 24.13 in.

## DC (Direct Current) Specifications

Electronic Controls DC input voltage requirement ----- 10.5 VDC to 16.0 VDC

### DC Fuse Requirements

Main Control Board (Power Board) F1-Control Circuit ----- 5-Amp, 32V, MINI ® Blade, Automotive Style Fuse  
Main Control Board (Power Board) F2-Auxiliary Circuit ----- 7.5-Amp, 32V, MINI ® Blade, Automotive Style Fuse  
DC Heater Board F1 (Optional - N7LX, N8LX models only) ----- 30-Amp, 32V, ATO/ATC Blade, Automotive Style Fuse

### DC Resistance / Amperage Ratings

Divider Heater ----- 43 Ω to 50 Ω, 240mA to 279mA @ 12 VDC  
DC Heater (3-Way models only) ----- 1 each, 6.7 Ω to 7.8 Ω, 16A to 18A @ 12 VDC  
Cold Weather Heater (optional) ----- 6.7 Ω to 7.8 Ω, 1.5A to 1.8A @ 12 VDC  
Ice Maker Water Line Heater (IM models only) ----- 6.7 Ω to 7.8 Ω, 1.5A to 1.8A @ 12 VDC  
External cooling fan ----- 430mA @ 12 VDC  
Interior Light ----- ≈180 mA

## AC (Alternating Current) Specifications

Electronic Controls AC input voltage requirement ----- 108VAC to 132VAC

### AC Fuse Requirements

Power Board F3 ----- 8-Amp, 250V Glass FST 5 x 20mm GMA Type

### AC Current Draw

AC Heater ----- 1 each, 300W @120VAC, (45.7 Ω to 50.5 Ω), 2.38A to 2.63A @ 120VAC  
Ice Maker Water Valve (IM models only) ----- 10W @ 120VAC

## Propane gas

Operating pressure ----- 10.5 - 11.5 inch w.c.  
Burner rating (Heat output) ----- 1750 Btu/h @ 11 in. W.C.  
Burner orifice size ----- LP18 (not replaceable)  
Gas ignition ----- Electronic with flame sensing  
Electrode tip-to-burner gap ----- 1/8 to 3/16 inch

## Off-level operating limits

Side-to-side ----- 3 degrees-maximum  
Front-to-back ----- 6 degrees-maximum

**Exploded Views**

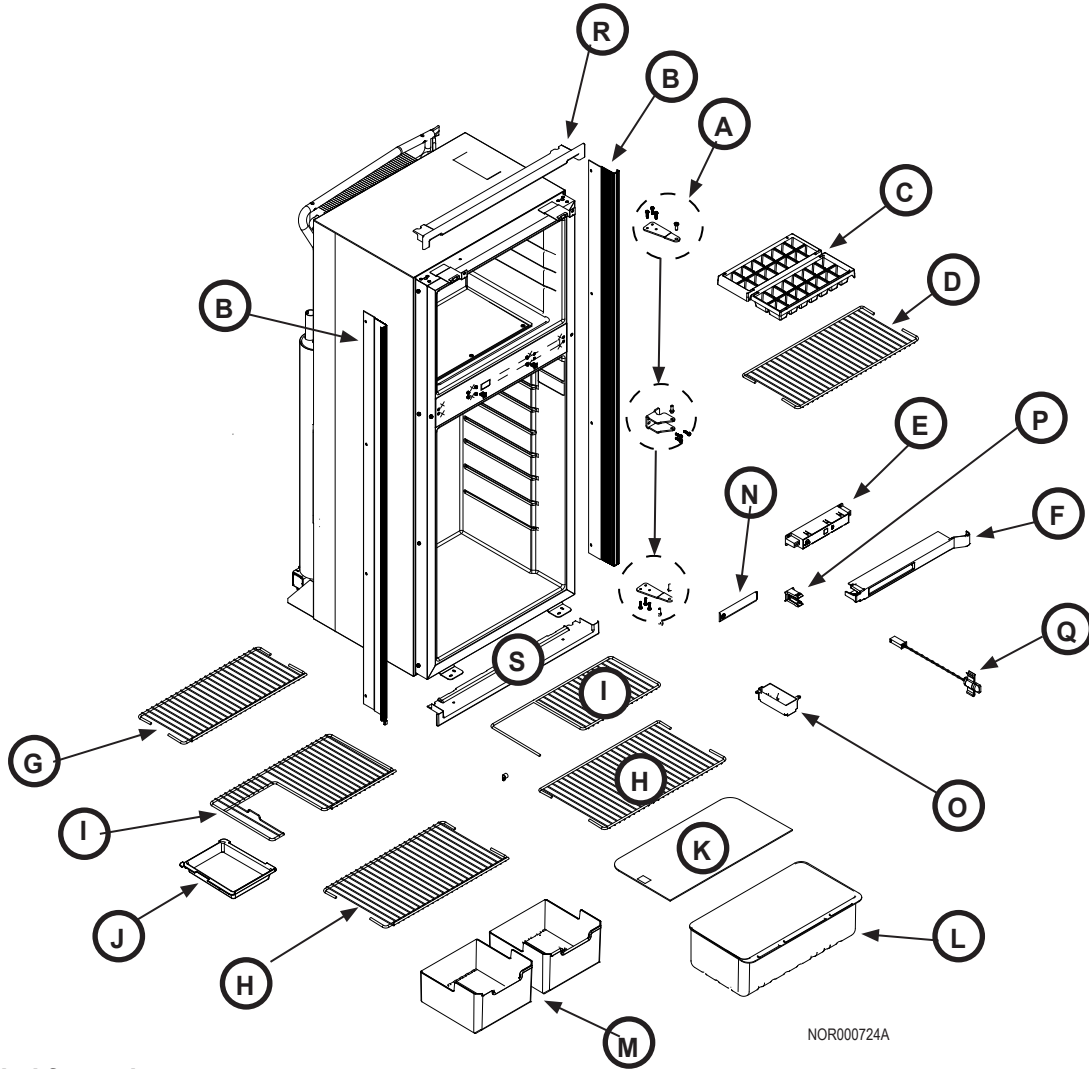

NOR000724A

**Fig. 4 - Exploded front view**

No.	Description
A	Hinges
B	Trim Piece / Foam Tape Assembly
C	Ice Cube Tray
D	Freezer Wire Shelf
E	User Interface Assembly (Control Assembly)
F	User Interface Housing (Control Housing)
G	Short Wire Shelf
H	Full Wire Shelf
I	Cut Out Wire Shelf

J	Shelf Tray
K	Crisper Cover / Glass Shelf
L	Crisper
M	Ice Bin
N	Hinge Hole Cover
O	LED Assembly
P	Strike Plate
Q	Thermistor
R	Top Trim Piece
S	Bottom Trim Piece

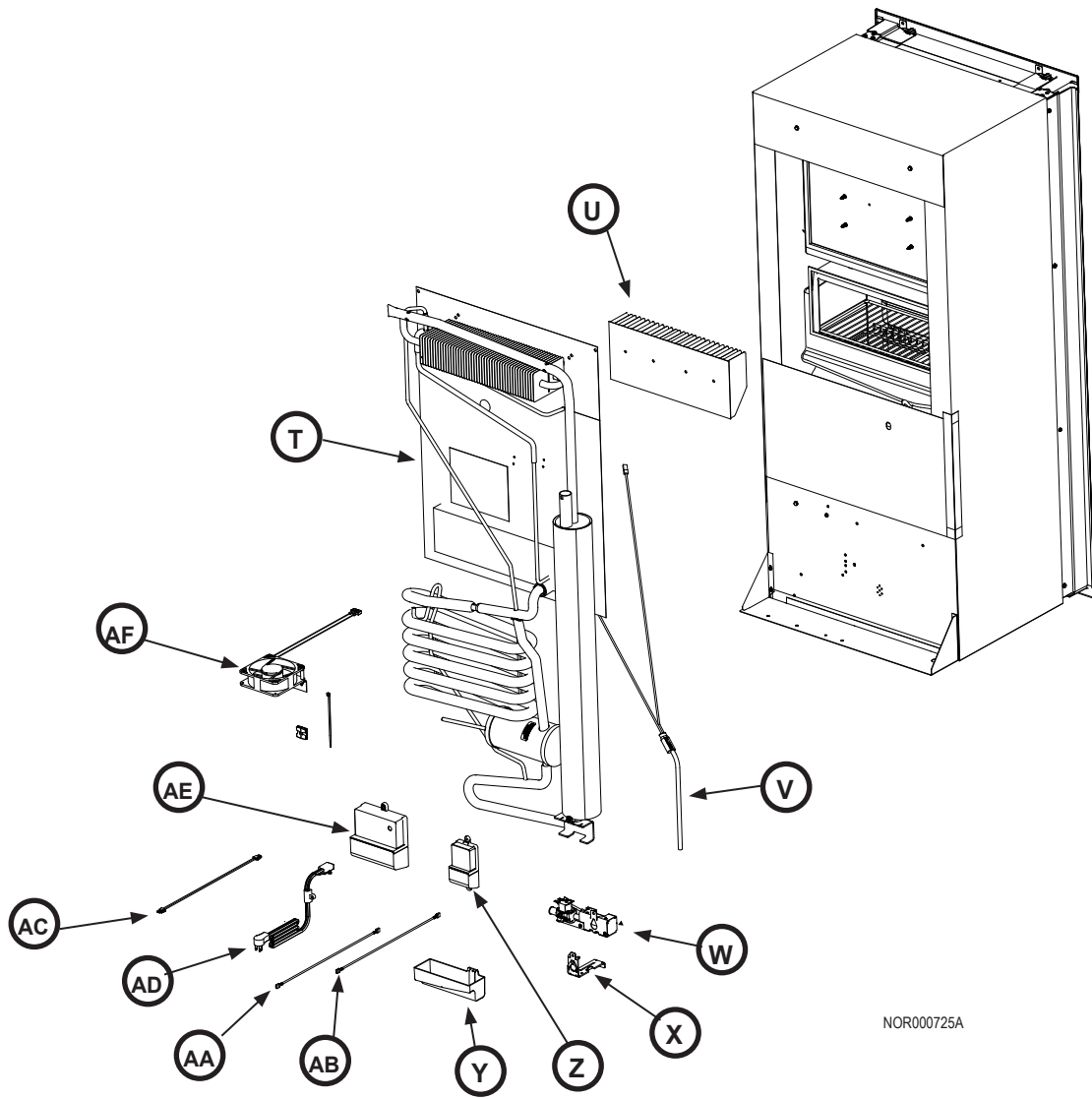

NOR000725A

**Fig. 5 - Exploded rear view**

No.	Description
T	Cooling Unit
U	Fins
V	AC Heater
W	Gas Train Assembly
X	Gas Train Support Bracket / Burner Door Assembly
Y	Drip Cup
Z	DC Board Assembly (3-way models only)
AA	Red Input Wire (3-way models only)
AB	Black Input Wire (3-way models only)
AC	Communication Harness (3-way models only)
AD	AC Power Cord
AE	Main Control Board Assembly (Power Board Assembly)
AF	Fan

# GENERAL INFORMATION

To confirm that installation is adequate, check for:

- Adequate ventilation - refer to "Ventilation Requirements" in the refrigerator Installation Manual.
- Both gas and electrical components installed and operating in a safe condition.
- Adequate seal between refrigerator mounting flange and cut-out opening.
- Installed on a solid floor (not on carpet) and secured.



This refrigerator is not intended to be operated as a free standing unit (i.e. where the products of combustion are not completely isolated from the living area) or installed in such a way as to conflict with these installation instructions. Unapproved installations could result in safety risks or performance problems.

## Ventilation

### Overview



The installed unit must be completely isolated from the combustion system of the refrigerator and it must have complete and unrestricted ventilation of the flue exhaust which, in gas mode, can produce carbon monoxide. The breathing of carbon monoxide fumes can cause dizziness, nausea, or in extreme cases, death.

Certified installation needs one lower intake vent and one upper exhaust vent. Install the vents through the side wall of the vehicle exactly as instructed in the Installation Manual. Any other installation method voids both the certification and the factory warranty of the refrigerator.

The bottom of the opening for the lower intake vent, which is also the service access door, must be even with or immediately below the floor level. This allows any leaking propane gas to escape to the outside and not to collect at floor level.

American Gas Association/Canadian Gas Association (AGA/CGA) certification allows the refrigerator to have zero (0) inch minimum clearance at the sides, rear, top, and bottom. While there are no maximum clearances specified for certification, the following maximum clearances are necessary for correct refrigeration:

Bottom	0 inch min.	0 inch max.
Each Side	0 inch min.	1/4 inch max.
Top	0 inch min.	1/4 inch max.
Rear	0 inch min.	1 inch max.

These clearances plus the lower and upper vents cause the natural air draft that is necessary for good refrigeration.

Cooler air goes in through the lower intake vent, goes around the refrigerator coils where it removes the excess heat from the refrigerator components, and goes out through the upper exhaust vent. If this air flow is blocked or decreased, the refrigerator may not cool correctly.

Each NORCOLD model is certified by AGA and CGA for correct ventilation.

## Enclosure

The cabinet that encloses the refrigerator is built by the RV manufacturer. Depending on cabinet depth, height, and width certain baffles may be present when cabinet clearances exceed installation guidelines and specifications.

## Baffles

Baffles prevent hot air buildup "pocketing" between the refrigerator cabinet and the enclosure walls and/or ceiling. An enclosure may be fitted with:

- An absorber baffle and a condenser baffle
- Side baffles (Fig. 6, A)
- Vertical top baffle (Fig. 6, B)
- Vertical angled baffles
- Box baffle
- Or a combination of any of the above

For complete detail about any necessary baffle(s), refer to the refrigerator Installation Manual.

## Lower Intake Vent

Ventilation and combustion air flow through the lower intake vent (Fig. 6, C), which also serves as the service access or door. The lower intake vent needs be kept clear of obstructions that may restrict the flow of fresh air into the enclosure.

## Exhaust Vent

Warm air and combustion gases flow out of the enclosure through the exhaust vent. The exhaust vent can be either a roof exhaust vent (Fig. 6, D) or an upper sidewall exhaust vent.

The roof exhaust vent has a non-removable metal mesh screen to prevent leaves, birds, rodents and/or debris from entering the enclosure.

## Roof Cap

The roof cap (Fig. 6, E) fits over exhaust vent. The sloped end always faces the front of the RV. It is held in place by four (4) 2-1/2" long Phillips head screws.

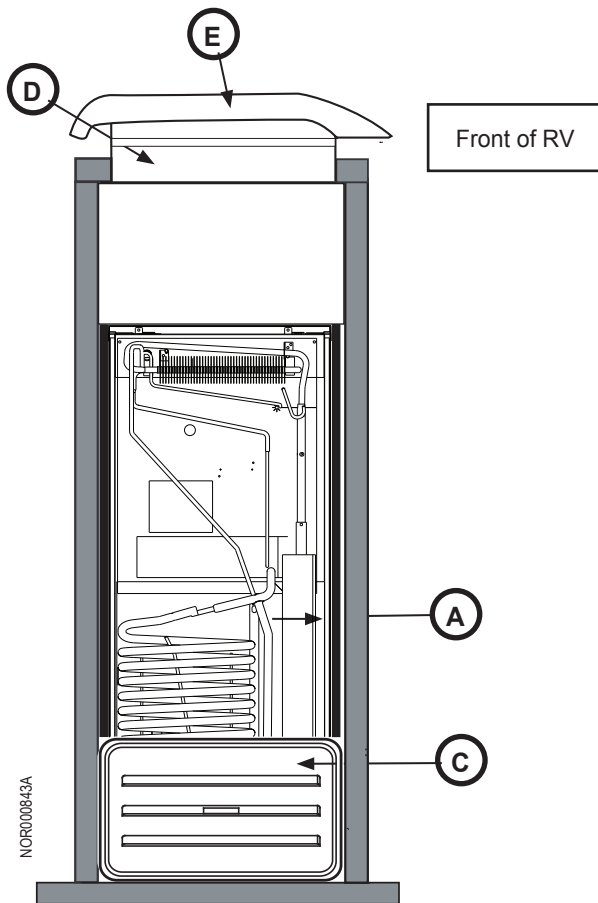

Fig. 6 - Typical roof exhaust venting

A	Side Baffles
B	Vertical Top Baffles
C	Lower Inake Vent
D	Roof Exhaust Vent
E	Roof Cap

## Propane Gas Connections

The refrigerator operates on propane gas at a pressure of 10.5 inches Water Column min. to 11.5 inches Water Column max.

**⚠ WARNING** Be very careful when working on or near the propane gas system.

- Do not smoke, or use an open flame near the propane gas system.
- Do not use an open flame to examine for leaks.
- Do not connect the refrigerator to the propane gas tank without a pressure regulator between them.

- To avoid possible propane gas leaks, always use two wrenches to tighten or loosen the propane gas supply line connections.
- Leaking propane gas can ignite or explode and result in dangerous personal injury or death.

**⚠ WARNING** Do not allow the leak detecting solution to touch the electrical components. Many liquids are electrically conductive and can cause a shock hazard, electrical shorts, and in some cases fire.

## Leak Test-Detergent

Using a solution of liquid detergent and water:

- Examine the propane gas supply system for leaks: make sure the propane gas supply line and all gas connections have no leaks. Do not use any liquid that contains ammonia.

## Electrical Connections

### 120 Volts AC Electrical Connection

The refrigerator is equipped with a three-prong plug for protection against shock hazard and must be connected into a recognized three-prong attachment receptacle. The cord must be routed so as not to come in contact with the burner cover, flue pipe or any other component that could damage the cord insulation.

**⚠ WARNING** Do not remove (cut) grounding plug from the refrigerator AC power cord. Removal of this prong can result in a severe electrical shock, as well as voiding the refrigerator's electrical certification and warranty.

- Verify AC power cord is in a grounded three-prong receptacle.
- Verify receptacle is within easy reach of the lower intake vent.
- Verify power cord does not touch the burner cover, the flue pipe, or any hot component that could damage the insulation of the power cord.

### 12 Volts DC Electrical Connection

The refrigerator controls require 12 volt DC to operate. The minimum control voltage is 10.5 volts DC. The maximum control voltage is 16.0 volts DC.

#### Polarity

The correct polarity of the DC leads to the main control board (power board) connections is:

- The 12 volt DC (positive) supply wire from the battery must be connected to the terminal marked "12 VDC" of the main control board (power board). On 3-way models, this connection is made to the DC control board terminal marked "12 VDC".
- The 12 volt DC (ground) supply wire from the battery must be connected to the terminal marked "GND" of the main control board (power board). On 3-way models, this connection is made to the DC control board terminal marked "GND".



## Main Control Board (Power Board) Fuses

There are three (3) fuses located on the main control board (power board). Two (2) are MINI ® Blade, Automotive Style Fuses used to protect DC voltage circuits (F1 and F2) and one (1) is a glass body cartridge style fuse (F3) used to protect AC voltage circuits.

### Fuse F1

This is a DCV, 5-Amp, 32V, MINI ® Blade, Automotive Style Fuse. It is used to protect the DC circuitry / componentry located on the Main Control Board (Power Board).

### Fuse F2

This is a DCV, 7.5-Amp, 32V, MINI ® Blade, Automotive Style Fuse. It is used to protect DC "loads" connected to the auxiliary output of the main control board (power board).

Examples of these loads are: External cooling fan, waterline heaters, etc.

### Fuse F3

This is an ACV, 8-Amp, 250V, Glass Body Cartridge, FST 5x20mm, Automotive Style Fuse. It is used to protect the AC circuitry / componentry located on the main control board (power board).

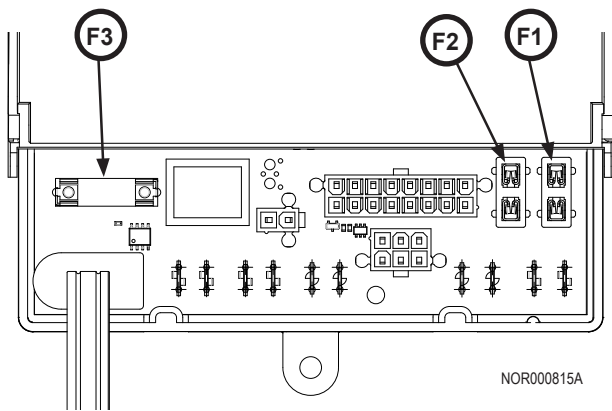

Fig. 7 - Fuse locations

## Electrical Components

### Interior Light

The interior light is located in the top of fresh food compartment. The light remains on at all times while the refrigerator is ON.

### Divider Heater

The divider heater is permanently "foamed into" the divider between the freezer compartment and the fresh food compartment. The divider heater warms this area to prevent condensation from forming. Powering on the refrigerator automatically powers on the divider heater. Power to the heater is continuously supplied by the main control board (power board).

## 12 Volt DC Fan

A 12 volt DC fan (Fig. 8, A) increases ventilation of the cooling system. The fan is located near the condenser on the rear of the cooling system foam plug. Fan resistance through the fan motor circuit is approximately 1.8 ohms.

The fan is unidirectional and is controlled by a thermostatic switch (Fig. 8, B).

The thermostatic switch is located on the first condenser fin (Fig. 8, C).

The switch turns the fan on and off. The fan comes on when the temperature of the first condenser fin is about 130° F (54.4° C) and turn off at about 115° F (46° C).

The DC power is supplied by an auxiliary wire harness (Fig. 8, D) through to connector pins P1-1 (Fig. 8, E) and P1-6 (Fig. 8, F).

**NOTICE** If the vehicle has a roof exhaust vent, you may need to remove the refrigerator from the enclosure to test the thermostatic switch. If the vehicle has an upper side-wall exhaust vent, you can test the thermostatic switch by removing the upper sidewall vent.

### Low Ambient Heater (optional)

Some models are factory equipped with a low ambient heater.

This heater is controlled by a thermostat. The thermostat allows DC voltage to the heater only while the refrigerator is turned ON and only when the ambient temperature is low enough.

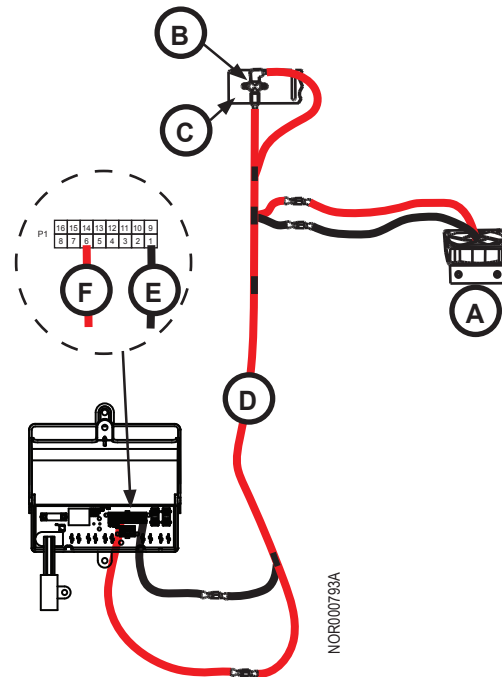

Fig. 8 - Fan wiring

A	Fan
B	Thermostatic Switch
C	Condenser
D	Auxiliary Wire Harness
E	P1-1 Auxiliary 12 VDC (ground)
F	P1-6 Auxiliary 12 VDC (positive)

## Temperature Control System

Although the refrigerator is not frost-free, it is made to limit frost on the cooling fins. At regular intervals, the temperature control system automatically melts most of the frost from the cooling fins. The water from the cooling fins drains into a collection cup attached to the back of the refrigerator. The heat of the cooling system evaporates the water from the collection cup.

## Backup Operating System

This refrigerator has a backup operating system. The backup operating system allows the refrigerator to continue to cool if the thermistor of the refrigerator should fail.

If a failure occurs:

- The refrigerator automatically changes to the backup operating system.
  - N7V and N8V models:
    - In Auto AC mode, the green power ON / indicator light will flash OFF once every 20 seconds and repeat until the thermistor is sensed to be operating correctly.
    - In Auto Propane Gas mode, the amber power ON / indicator light will flash OFF once every 20 seconds and repeat until the thermistor is sensed to be operating correctly.
  - N7X and N8X models:
    - In ANY mode, the temperature setting will flash ON and OFF for 10 seconds when the control is "awake".
  - N7LX and N8LX models:
    - In ANY mode, the temperature setting will flash ON and OFF for 10 seconds when the control is "awake".
- The backup operating system can over-freeze or thaw the contents of the freezer and the fresh food compartment.
  - Make sure the temperatures of the freezer and the fresh food compartment are satisfactory.

## PREVENTATIVE MAINTENANCE

An annual maintenance check is strongly recommended:

- Leak test the gas lines.
- Check combustion seal; repair or replace, if necessary (visual check without removing the refrigerator).
- Inspect or clean the openings of the burner tube.
- Check/adjust the spark electrode gap to 1/8 - 3/16 inch.
- Make sure the spark electrode tip is clean and the spark electrode is securely attached to the gas train assembly.
- Check/adjust AC and DC voltages and propane gas supply pressure.
- Make sure that area around the burner and controls is free of debris, oily rags, etc.
- Inspect the controls, piping and wiring to insure that they are in good condition.

### NOTICE

THESE MAINTENANCE PROCEDURES MUST BE PERFORMED BY A QUALIFIED SERVICE PERSON.

NORCOLD CANNOT ACCEPT RESPONSIBILITY FOR REPAIRS, ADJUSTMENT, OR MAINTENANCE PERFORMED BY OTHER THAN A QUALIFIED DEALER OR SERVICE CENTER.

## Gas Flame Appearance

While in propane gas operation, examine the appearance of the gas flame:

1. Change the refrigerator controls to the coldest temperature setting.
2. Open the lower intake vent.

### WARNING

The burner door can be hot. Wear gloves to avoid burns.

3. Open the burner door and look at the gas flame:
  - The flame should be a darker blue inside and a lighter blue outside and should be a constant and steady shape.
  - The flame should not be yellow and should not have an erratic and unstable shape.
  - Make sure the flame does not touch the inside of the flue tube.
4. Close the burner door.
5. Clean the openings of the burner tube as part of routine maintenance. Follow the instructions in the "Clean the Openings of the Burner Tube" section of these instructions. If the flame is not at peak performance, after the openings of the burner tube are cleaned, contact Customer Service.

## Clean the Openings of the Burner Tube

Clean the openings of the burner tube annually. To clean:

1. Close the valve at the vehicle propane gas tank(s).
2. Touch and hold the ON/OFF button (  ) for one (1) second to turn the refrigerator off.
3. Open the lower intake vent.
4. Disconnect the two (2) white wires from the gas train assembly (Fig. 9, A).

**⚠ WARNING** To avoid possible propane gas leaks, always use two (2) wrenches to loosen and tighten the gas supply line at the gas train assembly.

5. Disconnect the gas supply line from the gas train assembly.
6. Remove the two (2) screws (Fig. 9, B) that attach the gas train support bracket/door assembly (Fig. 9, C) to the cooling unit.

**⚠ WARNING** Never attempt to operate the gas train when it is NOT installed in the cooling unit because of the risk of electrical shock.

7. Remove the gas train assembly from the cooling unit.

**⚠ WARNING** When cleaning, do not try to remove the burner. Removal may cause a propane gas leak. Leaking propane gas can ignite or explode and result in dangerous personal injury or death. Do not try to clean the burner with anything other than compressed air.

8. Clean the openings of the burner tube with compressed air only. Blow air into the openings of the burner tube.
9. Put the gas train assembly back onto the cooling unit.
10. Attach the gas train support bracket/door assembly to the cooling unit.
11. Connect the gas supply line to the gas train assembly.
12. Connect the two (2) white wires to the gas valve of the gas train assembly.
13. Open the valve at the vehicle propane gas tank(s).
14. Examine all of the gas connections for leaks. Refer to the "Conduct Leak Test" procedure.

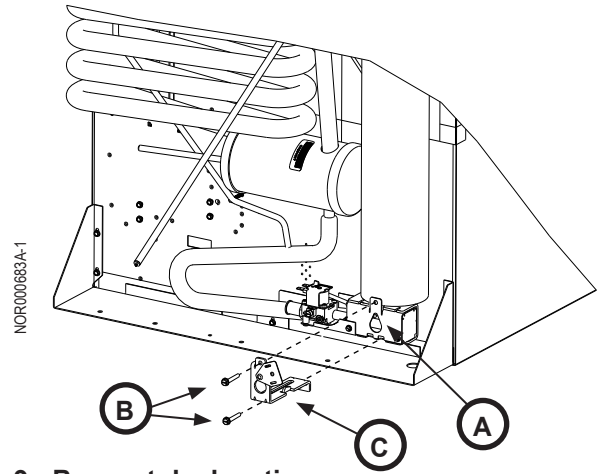

Fig. 9 - Burner tube location

A	Gas Train Assembly
B	Screws
C	Gas Train Support Bracket/Door Assembly

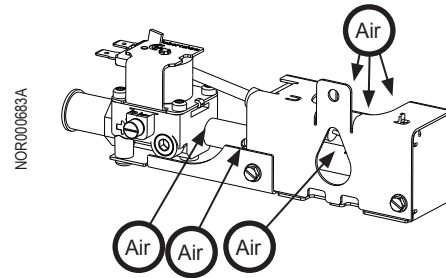
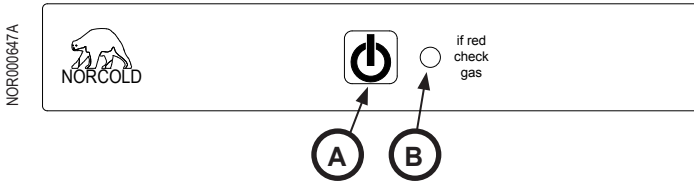

Fig. 10 - Openings of the burner tube

# USER INTERFACE (CONTROLS) - N7V AND N8V MODELS



**Fig. 11 - N7V and N8V user interface (control) locations**

No.	Description
A	Power ON / OFF button
B	Power ON / Indicator Light

## Power ON / OFF Button

Touch the Power ON / OFF button (See Fig. 11, A) to turn on the refrigerator.

Touch and hold the Power ON / OFF button for one (1) second to turn off the refrigerator.

## Modes of Operation

A precise heat is applied to the boiler area of the cooling unit causing a chemical reaction within the cooling unit that ultimately results in the refrigerator cooling. The heat is applied by means of:

- A 120 volt AC heater positioned in a heater well welded to the surface of the boiler. AC operation requires 108 to 132 volts AC. To replace the heater, the refrigerator must be removed from the enclosure.



**WARNING** Burn hazard! Allow canister and heaters to cool before attempting to remove and replace.

- A propane gas burner positioned below the boiler such that the heat from the flame is directed across the surface of the boiler. The controls energize the solenoid coil to open the gas valve. Spring pressure closes the valve when the controls stop the flow of current to the solenoid coil. The controls use an electronic sparker to ignite the propane gas at the burner.

These heat sources are turned on/off via a factory preset Auto mode. The unit will attempt to operate the heat source requirements in the following order of priority:

- **1st Priority Choice - Auto Mode**  
While in the Auto Mode, the AC cartridge heater is operated to provide heat to the boiler area of the cooling unit and the power ON / indicator light (See Fig. 11, B) is solid GREEN.
- **2nd Priority Choice - Propane Gas Mode**  
While in the Propane Gas Mode, the propane gas burner is operated to provide heat to the boiler area of the cooling unit and the power ON / indicator light is solid AMBER.
- Touch and hold the Power ON / OFF button for between 20-23 seconds to change the mode between Auto Mode and Manual Propane Gas Mode (See Fig. 12).
  - If the refrigerator is operating in Auto Mode, touch and hold the ON / OFF button. The green power ON indicator light will go out. Continue to hold the Power ON / OFF button for between 20-23 seconds. When the power ON indicator light comes on solid AMBER, release the Power ON / OFF button. The refrigerator is now operating in Manual Propane Gas Mode.
  - If the refrigerator is operating in Manual Propane Gas Mode, touch and hold the ON / OFF button. The amber power ON indicator light will go out. Continue to hold the Power ON / OFF button for between 20-23 seconds. When the power ON indicator light comes on solid GREEN, release the Power ON / OFF button. The refrigerator is now operating in Auto Mode.
- If the power ON / indicator light is solid RED, there is a problem and the refrigerator is not cooling. Refer to "Fault Codes N7V and N8V Models" section.

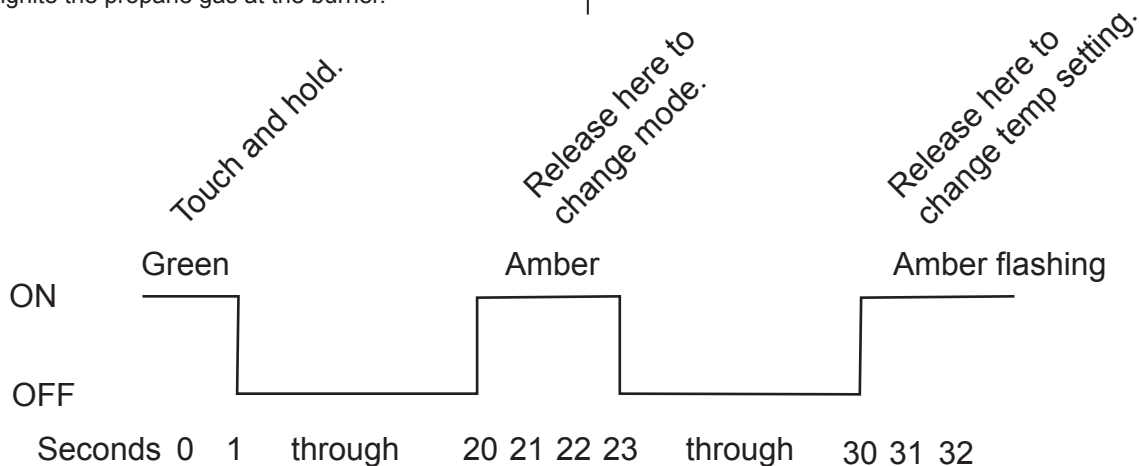

**Fig. 12 - Change mode and temperature setting**

A thermistor is mounted on the fin assembly located inside the fresh food compartment. The thermistor acts as a temperature sensor, reporting the temperature sensed to main control board (power board) which turns on/off the appropriate heat source accordingly. The user interface (controls), main control board assembly (power board assembly), thermistor, and other components within the refrigerator are interconnected via a wire harness.

## Air in the Propane Gas Supply Lines

### NOTICE

For safety reasons, the refrigerator electronic controls are designed so that while operating in Propane Gas Mode, the trial for ignition (the maximum time that the gas valve and the igniter can be left on without a flame present) is limited to 30 seconds. When starting the refrigerator for the first time, after storage, or after replacing the propane gas tanks(s), the propane gas supply lines can have air in them.

Due to the air in the gas supply lines, the burner may not ignite within the 30 second time limit. If this happens, the gas valve and igniter outputs will be turned off, the propane gas mode will be "locked out," and the appropriate fault code will show in the display.

The gas lock out condition can be reset by powering the refrigerator OFF and back ON, at which time a new 30 second trial for ignition will begin. You may need to repeat this procedure several times to remove all of the air from the gas supply lines.

## Refrigerator Temperature Settings

The user interface (controls) has three (3) temperature settings. The temperature setting can be changed within the temperature set mode of the user interface (controls). To enter the temperature set mode (See Fig. 12):

- Touch and hold the ON / OFF button. The power ON indicator light will go out. Continue to hold the Power ON / OFF button. The power ON indicator light will come on after 20 seconds and go off again after 23 seconds. Continue to hold the Power ON / OFF button. The power ON indicator light will come on again after 30 seconds. Release Power ON / OFF button.

The color of the power ON indicator light shows the current temperature setting of the refrigerator:

- Green shows the COLD temperature setting.
- Amber shows the COLDER temperature setting.
- Red shows the COLDEST temperature setting.

Touch and release the Power ON button and the Power ON / indicator light will flash on and off, which indicates that the temperature setting can be changed.

While the Power On indicator light is flashing, touch and release the Power ON button to change to each of the three (3) temperature settings, one at a time.

When the desired temperature setting is shown, touch and hold the Power ON button for ten (10) seconds to exit the temperature setting mode. The Power ON / indicator light will stop flashing and return to the solid GREEN or AMBER.

## Diagnostic Prechecks

Diagnosing fault codes begins by starting with the basics. In many cases, the problem can be solved by verifying the unit is operating in acceptable conditions:

- The refrigerator is plugged into a known working AC outlet with a voltage between 108VAC and 132VAC
- Extension cords are not being used to supply AC power to the refrigerator
- The refrigerator is connected to a known working DC power supply and/or battery supplying between 10.5 and 16.0 VDC
- Propane gas is available to the refrigerator and is regulated between 10.5 and 11.5" WC (Inches of Water Column).

# FAULT CODES - N7V AND N8V MODELS

## Fault Code Flash Patterns - N7V and N8V Models

The user interface (controls) has the ability to recognize various fault conditions and will display a unique error/fault code accordingly.

Should none of the heat source inputs be available, the power ON/ indicator light (See Fig. 12) will be solid RED.

ALL other fault codes will be displayed using flash patterns. The term “flash pattern” means the power ON / indicator light is turned ON and OFF to create a numeric pattern. These flash patterns directly correspond to particular fault codes. For example, fault code 3 will be indicated by flashing the power ON / indicator light RED 3-times, followed by a 5-second pause, and then repeated as long as the fault condition is present (See Fig. 13).

### NOTICE

The refrigerator is not cooling if the power ON / indicator light is either on solid RED or flashes on RED.

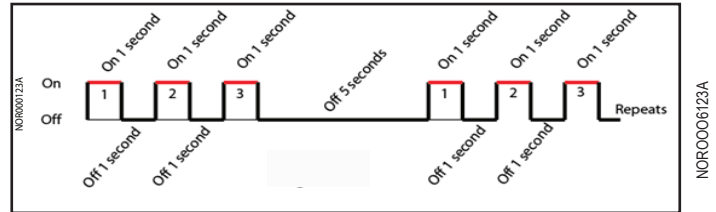









































Fig. 13 - Example fault code flash pattern

Fault Code Flash Pattern	Fault Code Meaning	Action to Take
   Flash Pattern Appears Here		
NOR000647-    Red, on solid.	The refrigerator tried to operate on the selected energy source(s) with no success.	Refer to “Fault - Code - Solid Red Indicator Light” on page 18.
   Red, flashes on one (1) time, is off five (5) seconds, repeats.	AC heater fault.	Refer to “Fault Code - Flash Pattern 1” on page 20.
   Red, flashes on two (2) times, is off five (5) seconds, repeats.	Internal control fault.	Refer to “Fault Code - Flash Pattern 2” on page 21.
   Red, flashes on three (3) times, is off five (5) seconds, repeats.	Internal control fault.	Refer to “Fault Code - Flash Pattern 3” on page 21.
   Red, flashes on four (4) times, is off five (5) seconds, repeats.	The AC heater relay stuck on.	Refer to “Fault Code - Flash Pattern 4” on page 21.
   Red, flashes on five (5) times, is off five (5) seconds, repeats.	A flame is sensed at the burner when there should be none present.	Refer to “Fault Code - Flash Pattern 5” on page 22.
   Red, flashes on eight (8) times, is off five (5) seconds, repeats.	The DC input voltage to the refrigerator is too low.	Refer to “Fault Code - Flash Pattern 8” on page 22.
   Red, flashes on nine (9) times, is off five (5) seconds, repeats.	The DC input voltage to the refrigerator is too high.	Refer to “Fault Code - Flash Pattern 9” on page 22.
   Red, flashes on ten (10) times, is off five (5) seconds, repeats.	Communications between the controls have been lost.	Refer to “Fault Code - Flash Pattern 10” on page 23.
   Green, flashes off once every twenty seconds.	The refrigerator is operating on AC electric power. The thermistor has been sensed as inoperable, so the temperature is being controlled via backup operating system.	Refer to “Fault Code - Thermistor Fault” on page 24
   Amber, flashes off once every twenty seconds.	The refrigerator is operating on propane gas. The thermistor has been sensed as inoperable, so the temperature is being controlled via a backup operating system.	Refer to “Fault Code - Thermistor Fault” on page 24.
  	The refrigerator is OFF.	Refer to “Blank Display” on page 25.



# TROUBLESHOOTING FLOWCHARTS - N7V AND N8V MODELS

## Fault - Code - Solid Red Indicator Light

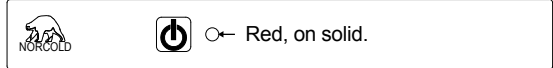
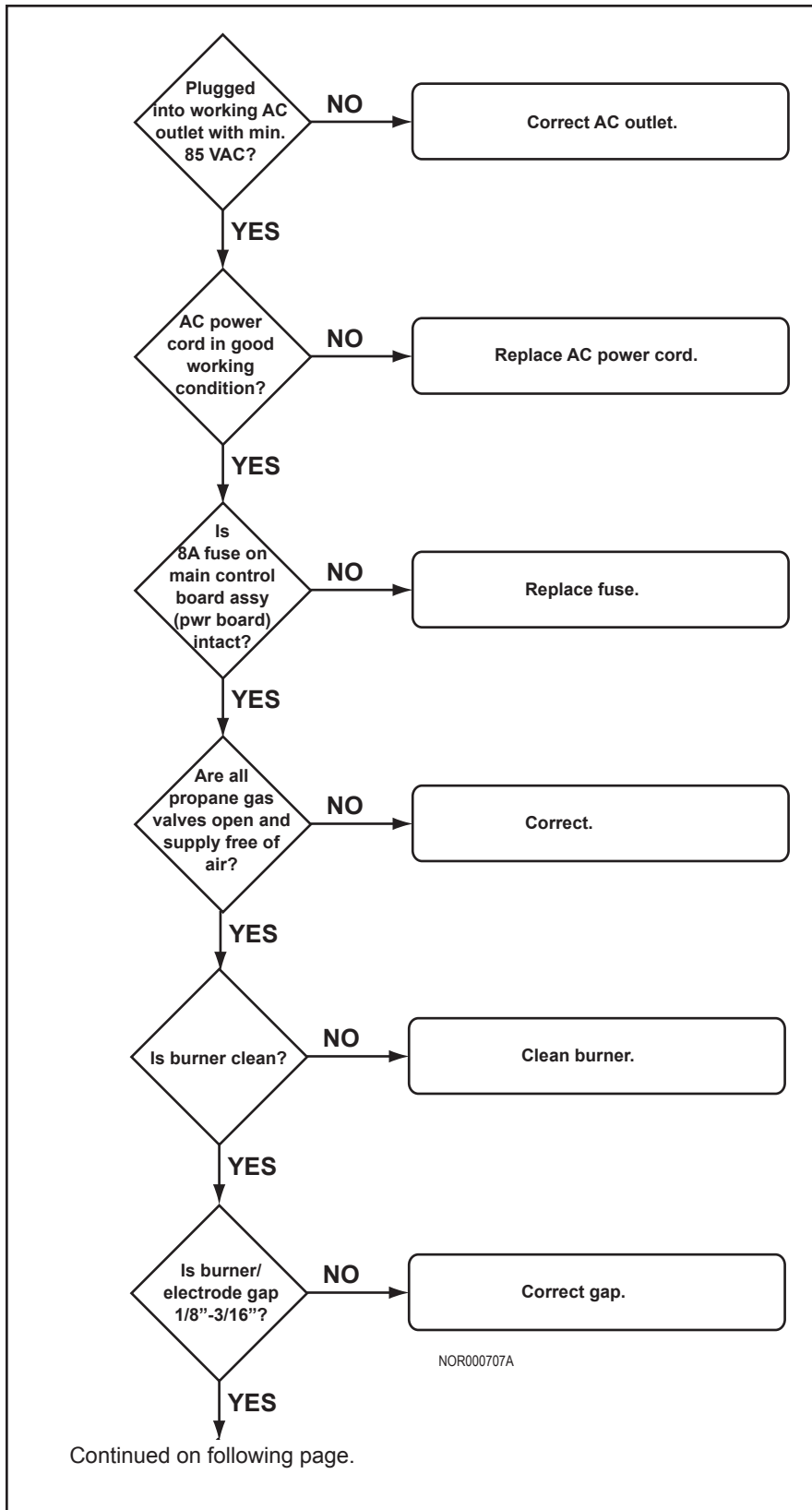

### Possible Cause:

120 VAC power is not available. Refrigerator defaulted to propane gas operation, but did not establish a flame.(Gas Lockout).

Turn the refrigerator OFF and then back ON to reset.



Continued from previous page.

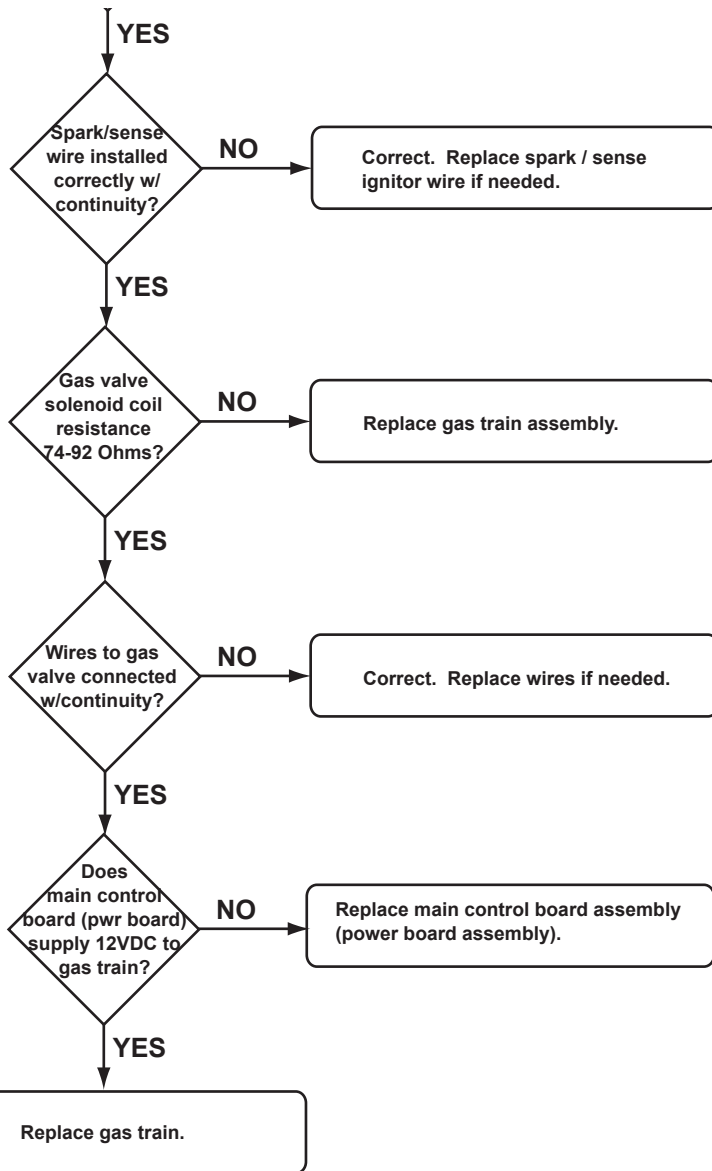

NOR000707A

## Fault Code - Flash Pattern 1



Red, flashes on one (1) time, is off five (5) seconds, repeats.

Before starting this procedure:

- Make sure that the AC voltage to the refrigerator is 108-132 VAC.
- Make sure no other appliance or lighting circuit is connected to the refrigerator AC circuit.

The AC is off when it should be on. AC heater "lockout". Turn the refrigerator OFF and then back ON to reset.

**Possible Cause:**

- AC heater fault.
- The AC heater is not plugged in.
- The AC heater failed open.

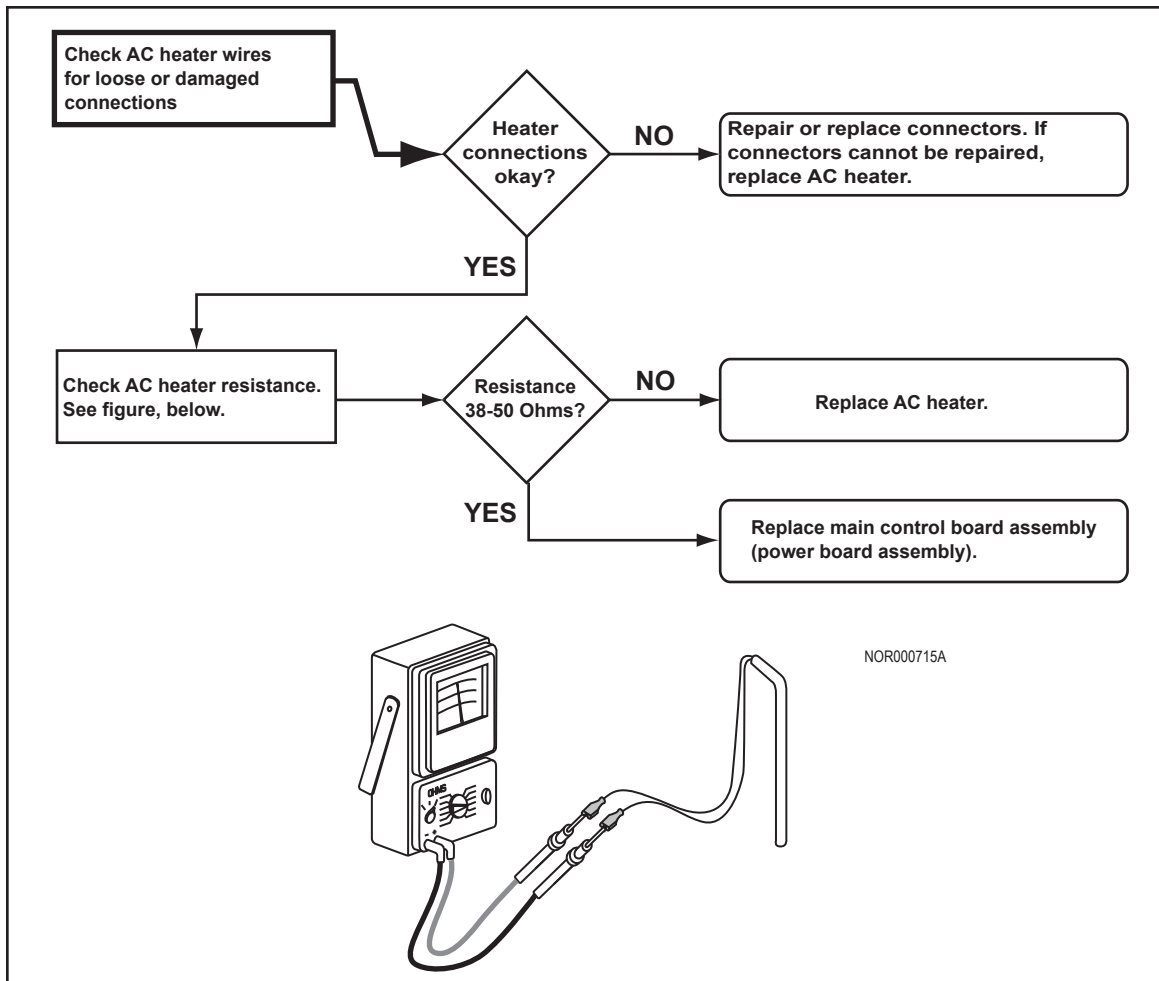

### Fault Code - Flash Pattern 2

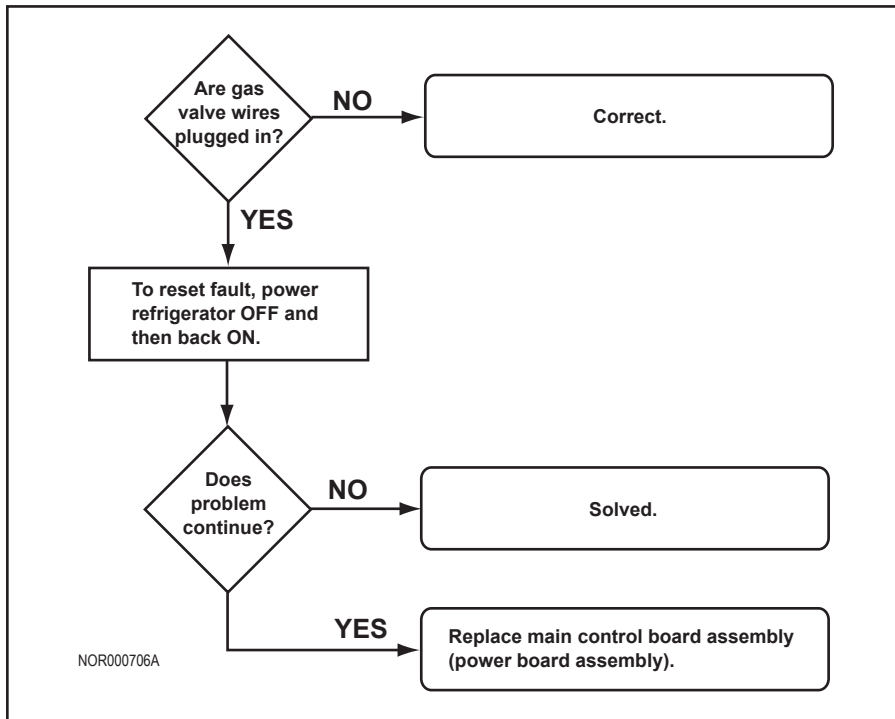

Red, flashes on two (2) times, is off five (5) seconds, repeats.

**Possible Cause:**

The main control board assembly (power board) detected an internal fault. This fault can be displayed in any MODE.

### Fault Code - Flash Pattern 3

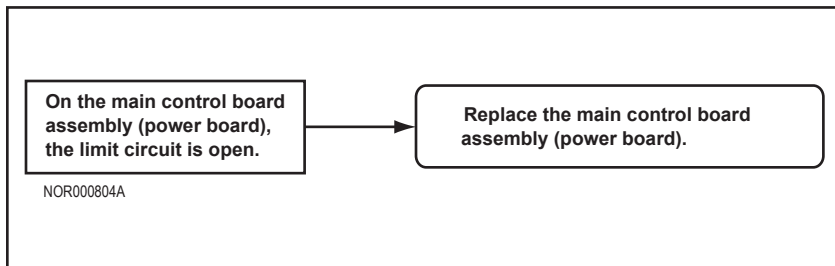

Red, flashes on three (3) times, is off five (5) seconds, repeats.

**Possible Cause:**

On the main control board assembly (power board), the limit circuit is open.

### Fault Code - Flash Pattern 4

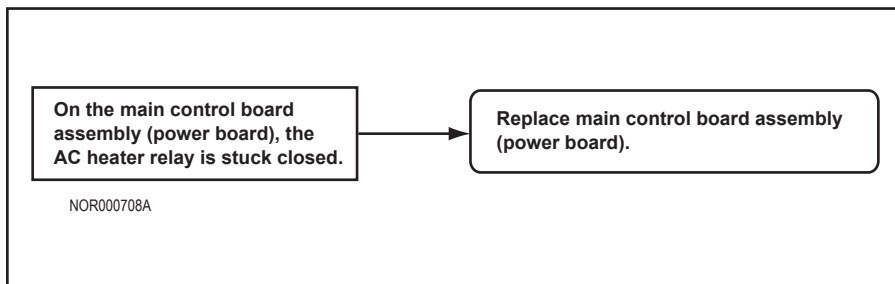

Red, flashes on four (4) times, is off five (5) seconds, repeats.

**Possible Cause:**

On the main control board assembly (power board), the AC heater relay is stuck closed.

## Fault Code - Flash Pattern 5

---

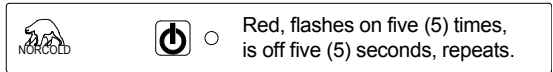
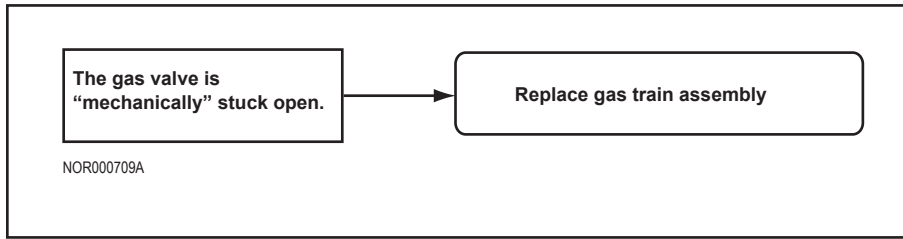

A flame is sensed at the burner when there should be none present.

**Possible Cause:**

The gas valve is "mechanically" stuck open. Therefore, the main control board senses a flame is present at the burner when there should be none

## Fault Code - Flash Pattern 8

---

Correct the DC input voltage to the refrigerator. Make sure the input voltage is 12.0 VDC.

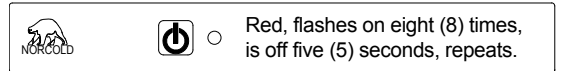

**Possible Cause:**

The DC input voltage to the refrigerator is too low.

## Fault Code - Flash Pattern 9

---

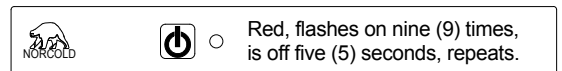

Correct the DC input voltage to the refrigerator. Make sure the input voltage is 12.0 VDC.



**Possible Cause:**

The DC input voltage to the refrigerator is too high.

### Fault Code - Flash Pattern 10

  Red, flashes on ten (10) times, is off five (5) seconds, repeats.

**Possible Cause:**

Communications between the user interface (controls) and the main control board assembly (power board) have been lost.

Check that the blue wire, within the main wire harness, is fully plugged in; both at P1-14 of main control board assembly (power board) and P1-3 of user interface (optical display).



Correct connections.

With the wire harness unplugged from the main control board assembly (power board) and the user interface (optical display), check continuity of the blue wire to make sure the wire is not "open".



Check that there is NO continuity between the blue wire and ground.

Replace the refrigerator.



Shorted to ground. Replace the refrigerator.

Check that there is NO continuity between the blue wire and any of the other wires of the wire harness.





Shorted to another wire. Replace the refrigerator.

Reconnect the wire harness at main control board assembly (power board) and the user interface (optical display).

Replace the main control board assembly (power board).

NOR000796A

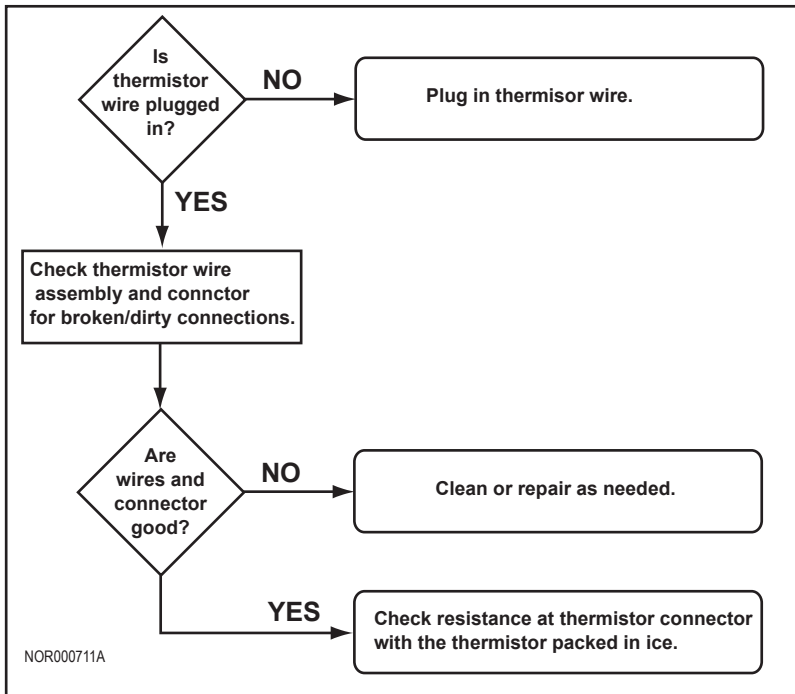

## Fault Code - Thermistor Fault

Green, flashes off once every twenty seconds.

**Possible Cause:**

The refrigerator is operating on AC electric power. The thermistor has been sensed as inoperable, so temperature is being controlled via backup operating system.

Amber, flashes off once every twenty seconds.

**Possible Cause:**

The refrigerator is operating on propane gas. The thermistor has been sensed as inoperable, so temperature is being controlled via backup operating system.

Temperature* (°F)	Resistance* (k Ω)
85	8.1 - 9.0
80	9.1 - 10.0
75	10.1 - 11.0
70	11.1 - 12.0
60	12.1 - 13.0
50	15.5 - 16.5
40	22.5 - 23.5
35	24.5 - 25.5
33	28.5 - 29.5
32	30.0 - 32.0
* Approximate values	

# Blank Display

Before starting this procedure verify:

- Vehicle DC voltage to the refrigerator is 10.5 to 16.0 volts.
- No other appliance or lighting circuit is connected to the refrigerator DC circuit.
- DC input of the vehicle is wired into the main control board according to the Refrigerator Installation Manual.



Blank display.

**Possible Cause:**

The refrigerator will not turn ON.

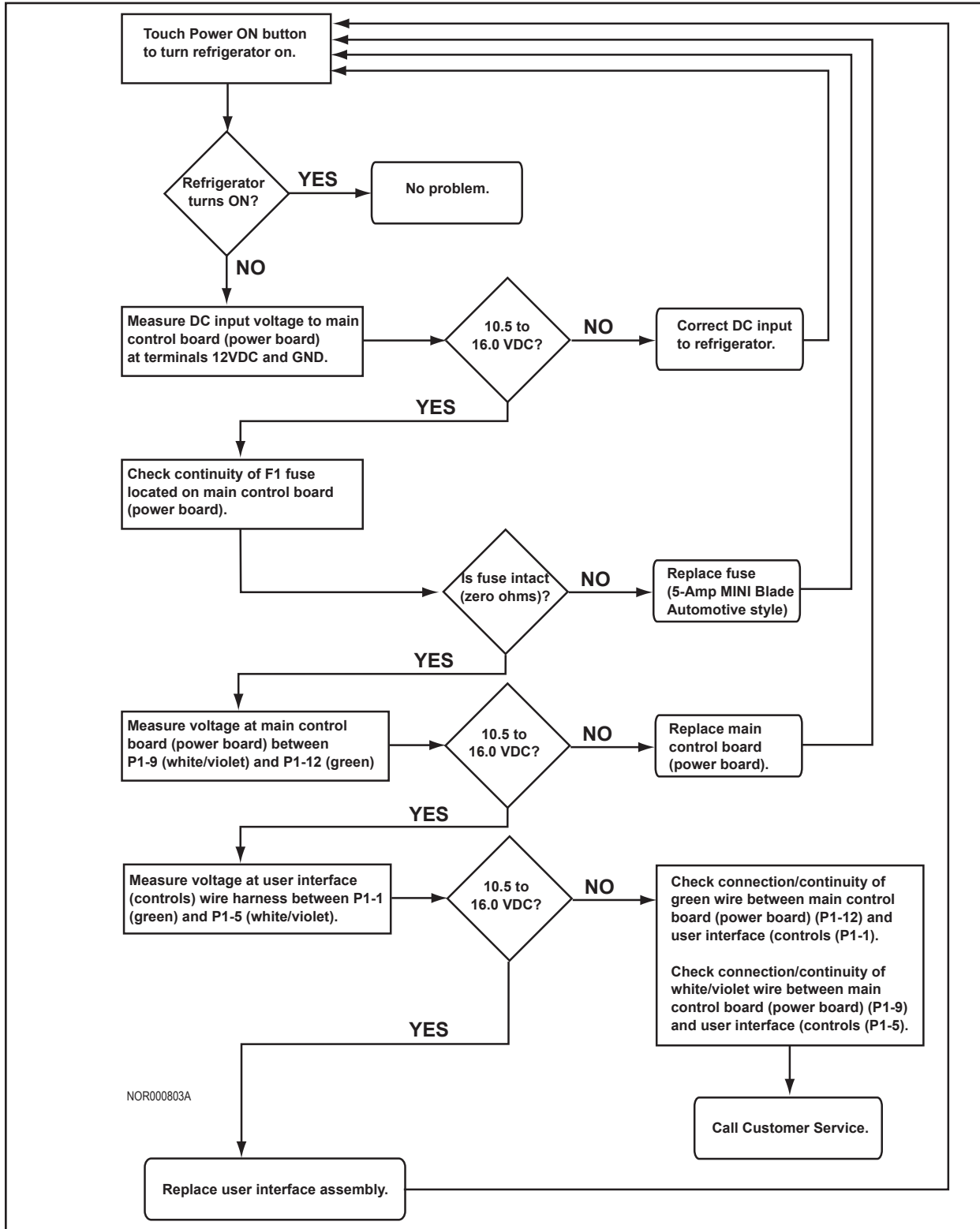

NOR000803A



# USER INTERFACE (CONTROLS) - N7X AND N8X MODELS

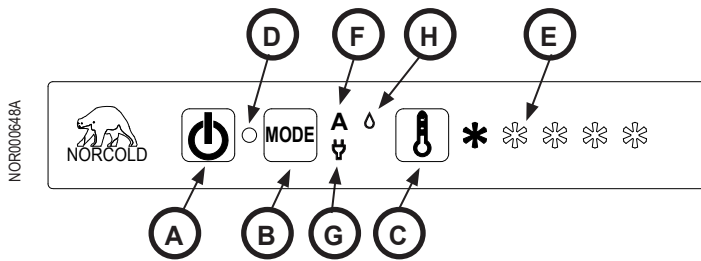

Fig. 14 - N7X and N8X user interface (control) locations

No.	Description
A	Power ON / OFF Button
B	Mode Button
C	Temperature Set Button
D	Power ON / Indicator Light
E	Temperature Setting Indicators
F	AUTO Mode Indicator
G	AC Mode Indicator
H	Gas Mode Indicator

## Power ON / OFF Button

Touch the Power ON / OFF button (See Fig. 14, A) to turn on the refrigerator.

Touch and hold the Power ON / OFF button for one (1) second to turn off the refrigerator.

## Mode Button

The mode button is manually operated and does not automatically change the operating mode of the refrigerator.

Touch and hold the Mode button (See Fig. 14, B) to scroll through the available modes of operation of the refrigerator, one after the other. When the desired mode indicator(s) comes on, release the Mode button.

Or touch and release the Mode button to change the available modes of operation one at a time. There are one (1) Automatic and two (2) Manual Modes of operation.

- AUTO Mode: The AUTO Mode indicator (See Fig. 14, F) comes on and the refrigerator controls automatically select the most efficient energy source that is available.
  - If available, the refrigerator controls select AC electric as the power choice and the AC mode indicator (See Fig. 14, G) comes on also.
  - If AC electric is not available, the controls select gas as the power choice and the gas mode indicator (See Fig. 14, H) comes on also.

- MANUAL AC mode: The refrigerator operates using only AC electric as the power source and the AC mode indicator only comes on.
- MANUAL GAS mode: The refrigerator operates using only propane gas as the power source and the propane gas mode indicator only comes on.

## Temperature Set Button

Touch and release the Temperature Set button (See Fig. 14, C) to view the current temperature setting.

Then touch and release the Temperature Set button to change the temperature settings, one at a time.

Or touch and hold the Temperature Set button to scroll through temperature settings, one after the other. Release the Temperature Set button when the desired temperature setting appears. There are five (5) temperature settings.

## Temperature Setting Indicators

There are five (5) temperature setting indicators (See Fig. 14, E).

- When only one (1) temperature setting indicator is on, the temperature setting is the warmest.
- When all five (5) temperature setting indicators are on, the temperature setting is the coldest.

## Gas Mode Operation

In AUTO GAS mode and MANUAL GAS mode, the controls energize the solenoid coil to open the gas valve. Spring pressure closes the valve when the controls stop the flow of current to the solenoid coil.

The propane gas burner will cycle in response to the fin temperature to maintain cabinet temperature.

The controls use an electronic sparker to ignite the propane gas at the burner.

When either AUTO or MANUAL GAS mode is selected, the refrigerator attempts to ignite the propane gas burner. If unable to ignite the burner and to maintain a flame, the Power ON / Indicator light changes from amber to red. Refer to "Fault Codes" section.

## AC Mode Operation

AUTO AC or MANUAL AC mode operation requires 108 to 132 volts AC. Voltage is to be supplied through a 2 pole, 3-wire, 20 Amp grounding type receptacle.

A 120 volt AC heater generates the heat load required for AUTO AC and Manual AC operation. To replace the heater, the refrigerator must be removed from the enclosure.



Burn hazard! Allow canister and heater to cool before attempting to remove and replace.

The AC electric heater will cycle in response to the fin temperature to maintain the cabinet temperature.

## Air in the Propane Gas Supply Lines

### NOTICE

For safety reasons, the refrigerator electronic controls are designed so that while operating in Propane Gas Mode, the trial for ignition (the maximum time that the gas valve and the igniter can be left on without a flame present) is limited to 30 seconds. When starting the refrigerator for the first time, after storage, or after replacing the propane gas tanks(s), the propane gas supply lines can have air in them.

Due to the air in the gas supply lines, the burner may not ignite within the 30 second time limit. If this happens, the gas valve and igniter outputs will be turned off, the propane gas mode will be "locked out", and the appropriate fault code will show in the display.

The gas lock out condition can be reset by powering the refrigerator OFF and back ON, at which time a new 30 second trial for ignition will begin. You may need to repeat this procedure several times to remove all of the air from the gas supply lines.

## Diagnostic Prechecks

Diagnosing fault codes begins by starting with the basics. In many cases, the problem can be solved by verifying the unit is operating in acceptable conditions:

1. The refrigerator is plugged into a known working AC outlet with a voltage between 108VAC and 132VAC
2. Extension cords are not being used to supply AC power to the refrigerator
3. The refrigerator is connected to a known working DC power supply and/or battery supplying between 10.5 and 16.0 VDC
4. Propane gas is available to the refrigerator and is regulated between 10.5 and 11.5" WC (Inches of Water Column)

## FAULT CODES - N7X AND N8X MODELS

### Fault Code Flash Patterns - N7X and N8X Models

The N7X and N8X controls have the ability to recognize various fault conditions and will display a unique error/fault code accordingly.







Should none of the heat source inputs be available, the power ON / indicator light (See Fig. 14, D) will be solid RED.

ALL other fault codes will be displayed using flash patterns. The term "flash pattern" means the power ON / indicator light is turned ON and OFF to create a numeric pattern. These flash patterns directly correspond to particular fault codes. For example, fault code 3 will be indicated by flashing the power ON / indicator light RED 3-times, followed by a 5-second pause, and then repeated as long as the fault condition is present (See Fig. 13).

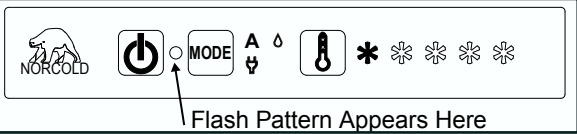
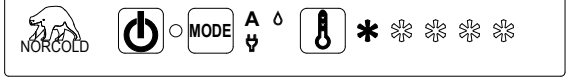
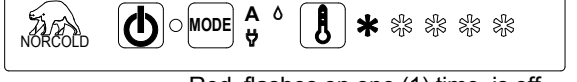
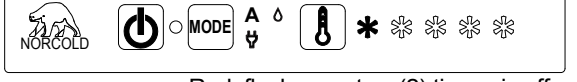
### NOTICE

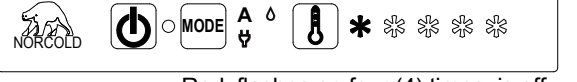
The refrigerator is not cooling if the power ON / indicator light [185] is either on solid RED or flashes on RED.

### Fault Code - Flash Patterns

<p style="text-align: center;"><b>Fault Code Flash Pattern</b></p> 	<p style="text-align: center;"><b>Fault Code Meaning</b></p>	<p style="text-align: center;"><b>Action to Take</b></p>
 <p style="text-align: center;">Red, on solid.</p>	<p>The refrigerator tried to operate on the selected energy source(s) with no success.</p>	<p>Refer to "Fault Code - Solid Red Indicator Light" on page 29.</p>
 <p style="text-align: center;">Red, flashes on one (1) time, is off five (5) seconds, repeats.</p>	<p>AC heater fault.</p>	<p>Refer to "Fault Code - Flash Pattern 1" on page 31.</p>
 <p style="text-align: center;">Red, flashes on two (2) times, is off five (5) seconds, repeats.</p>	<p>Internal control fault.</p>	<p>Refer to "Fault Code - Flash Pattern 2" on page 32.</p>
 <p style="text-align: center;">Red, flashes on three (3) times, is off five (5) seconds, repeats.</p>	<p>Internal control fault.</p>	<p>Refer to "Fault Code - Flash Pattern 3" on page 32.</p>
 <p style="text-align: center;">Red, flashes on four (4) times, is off five (5) seconds, repeats.</p>	<p>AC heater relay stuck on.</p>	<p>Refer to "Fault Code - Flash Pattern 4" on page 32.</p>
 <p style="text-align: center;">Red, flashes on five (5) times, is off five (5) seconds, repeats.</p>	<p>A flame is sensed at the burner when there should be none present.</p>	<p>Refer to "Fault Code - Flash Pattern 5" on page 33.</p>
 <p style="text-align: center;">Red, flashes on eight (8) times, is off five (5) seconds, repeats.</p>	<p>The DC input voltage to the refrigerator is too low.</p>	<p>Refer to "Fault Code - Flash Pattern 8" on page 33.</p>
 <p style="text-align: center;">Red, flashes on nine (9) times, is off five (5) seconds, repeats.</p>	<p>The DC input voltage to the refrigerator is too high.</p>	<p>Refer to "Fault Code - Flash Pattern 9" on page 33.</p>
 <p style="text-align: center;">Red, flashes on ten (10) times, is off five (5) seconds, repeats.</p>	<p>Communications between the controls have been lost.</p>	<p>Refer to "Fault Code - Flash Pattern 10" on page 34.</p>

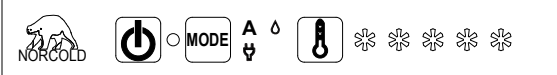
 <p>Temperature setting snowflake(s) flash on/off at one (1) second intervals anytime the user interface (control) is "awake".</p>	<p>The thermistor has been sensed as inoperable, so the temperature is being controlled via backup operating system.</p>	<p>Refer to "Fault Code - Thermistor Fault" on page 35.</p>
 <p>Blank display.</p>	<p>The refrigerator is OFF.</p>	<p>Refer to "Blank Display" on page 36.</p>

## TROUBLESHOOTING FLOWCHARTS - N7X AND N8X MODELS

### Fault Code - Solid Red Indicator Light

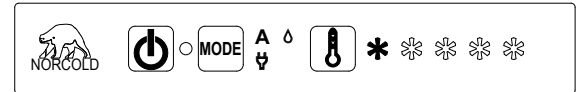
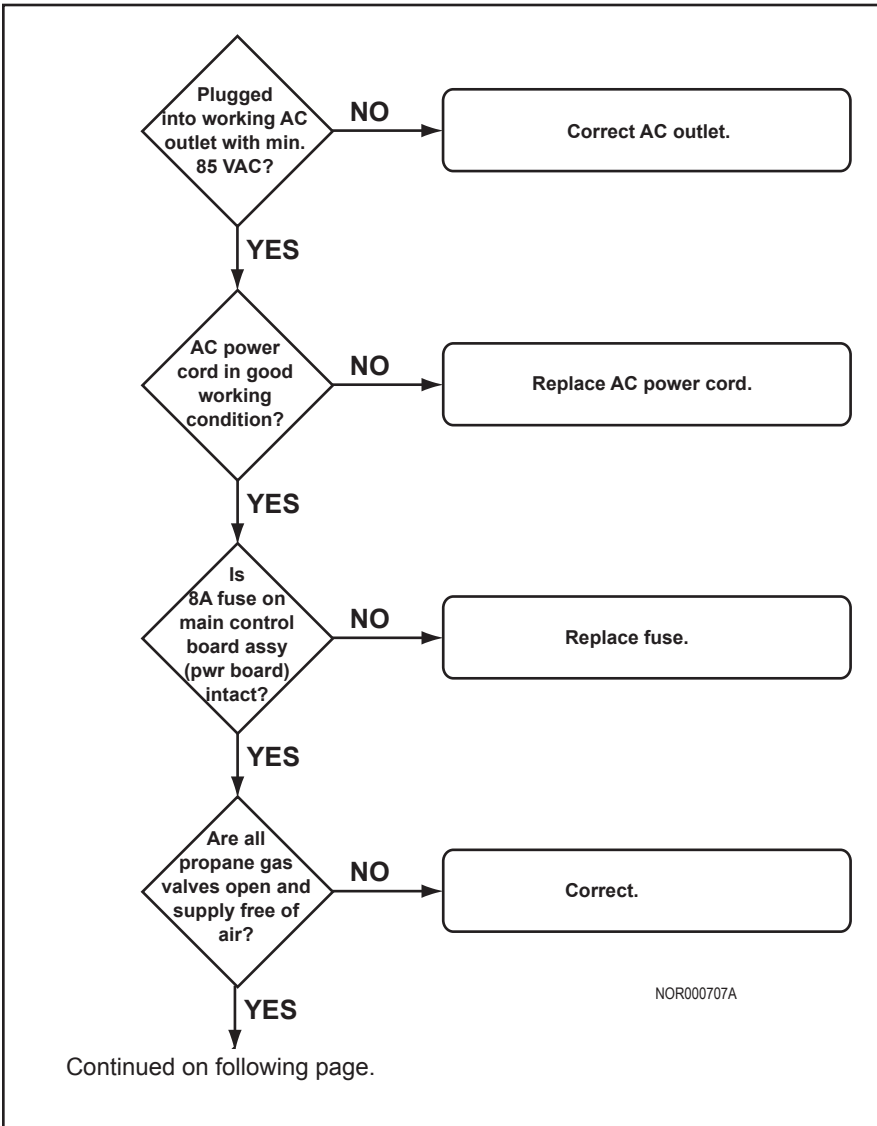

Red, on solid.

**Possible Cause:**

120 VAC power is not available. Refrigerator defaulted to propane gas operation, but did not establish a flame. (Gas Lockout).

Turn the refrigerator OFF and then back ON to reset.

Continued from previous page.

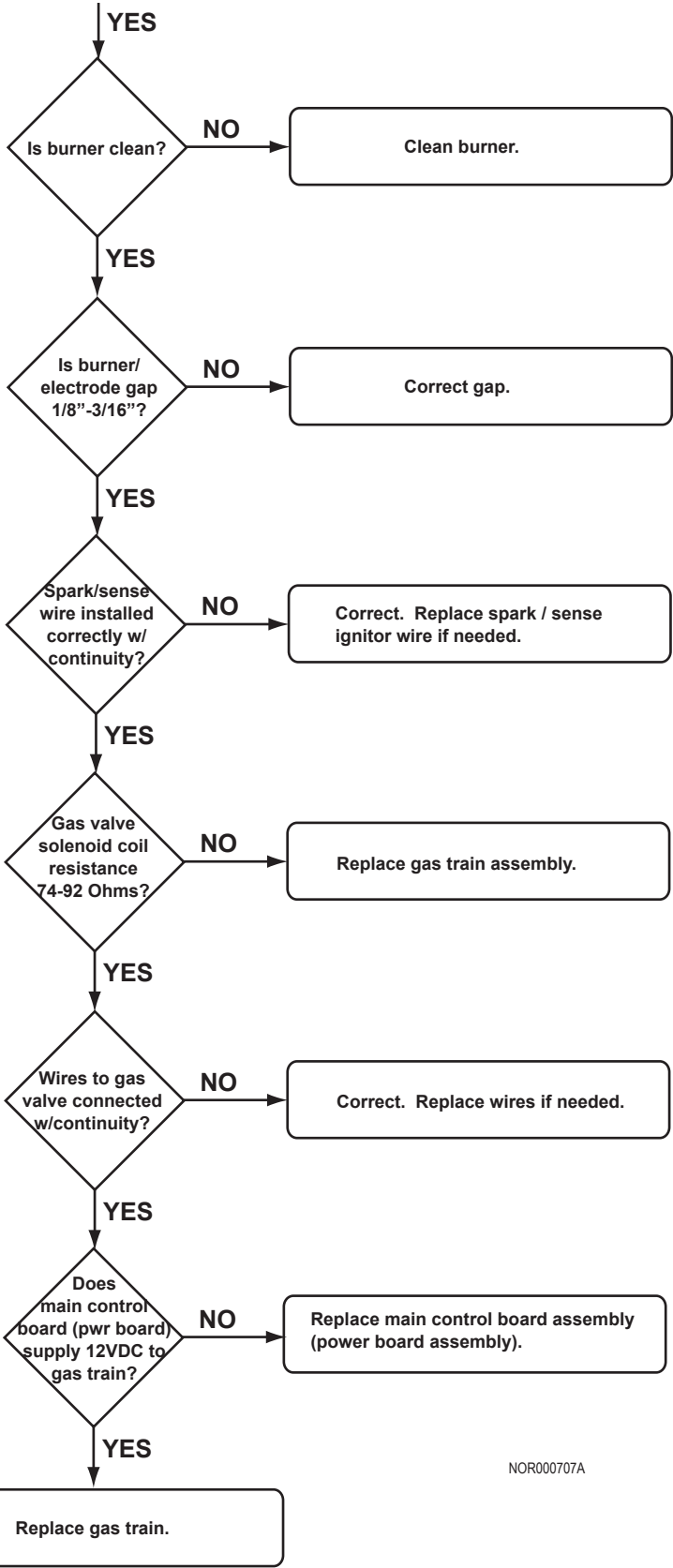

NOR000707A

## Fault Code - Flash Pattern 1

Before starting this procedure:

- Make sure that the AC voltage to the refrigerator is 108-132 VAC.
- Make sure no other appliance or lighting circuit is connected to the refrigerator AC circuit.

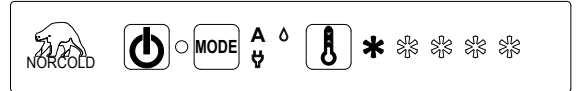

Red, flashes on one (1) time, is off five (5) seconds, repeats.

The AC is off when it should be on. AC heater "lockout". Turn the refrigerator OFF and then back ON to reset.

**Possible Cause:**

- AC heater fault.
- The AC heater is not plugged in.
- The AC heater failed open.

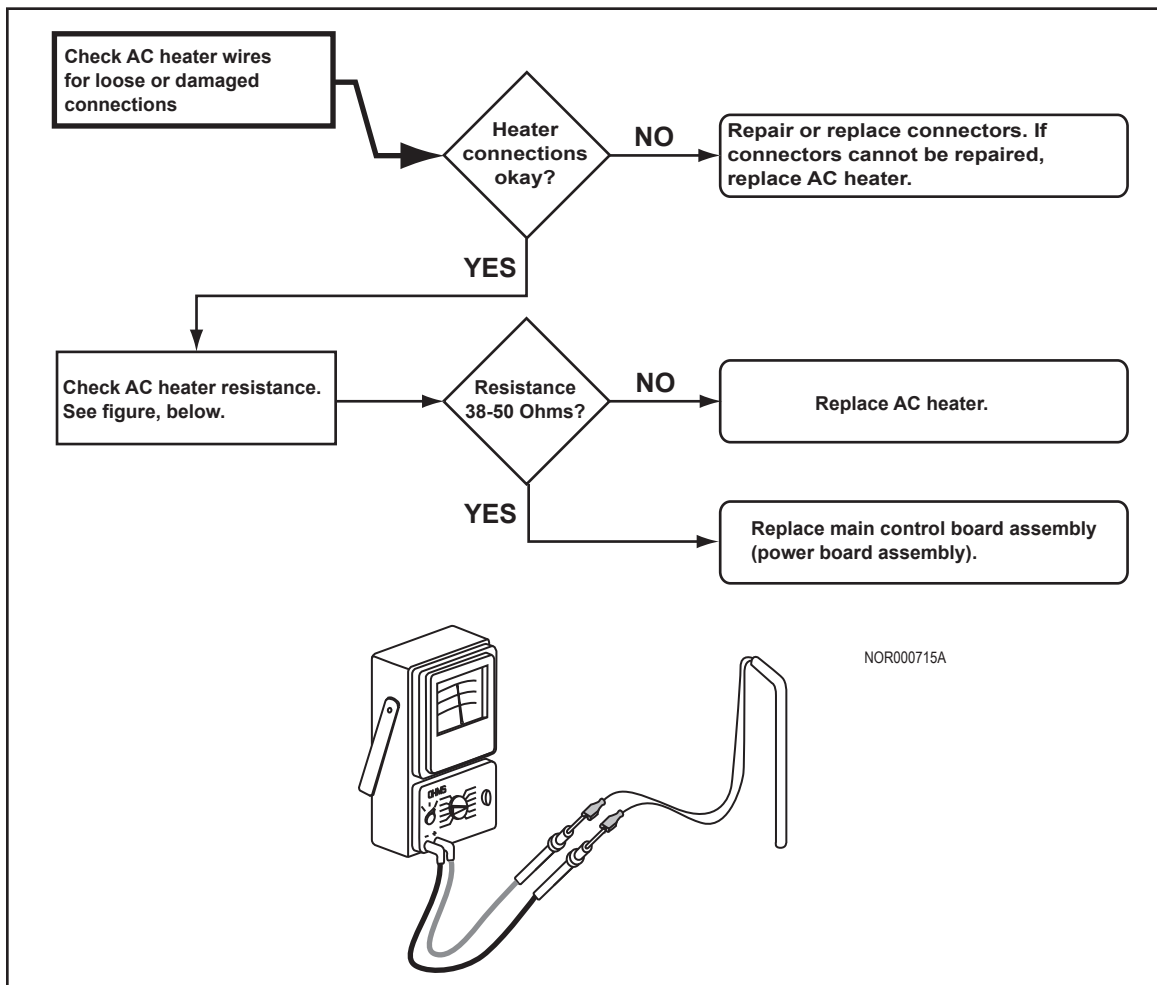

## Fault Code - Flash Pattern 2

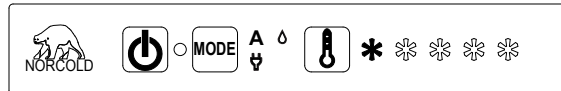
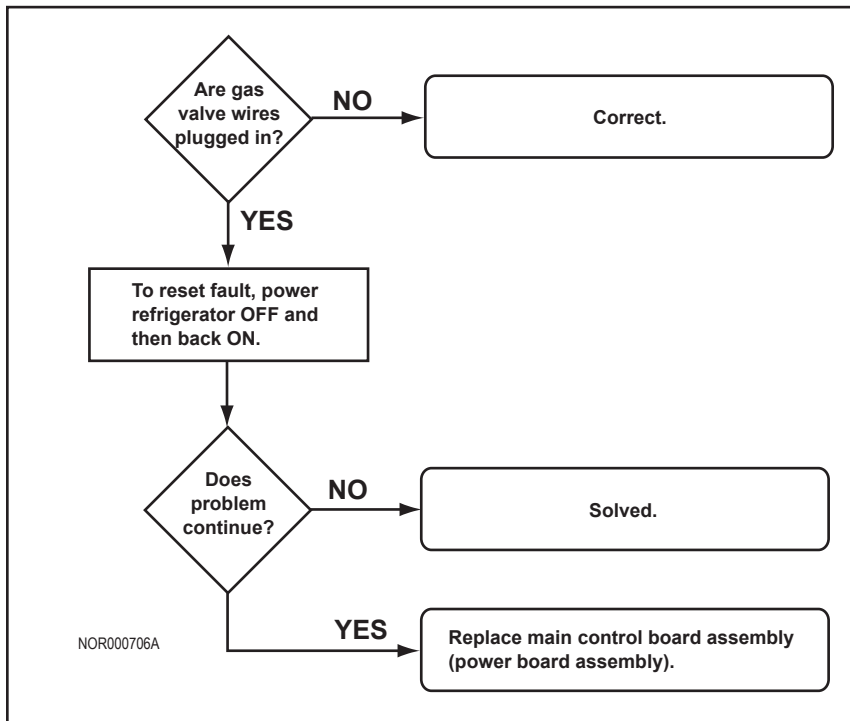

Red, flashes on two (2) times, is off five (5) seconds, repeats.

### Possible Cause:

The main control board assembly (power board) detected an internal fault. This fault can be displayed in any MODE.

## Fault Code - Flash Pattern 3

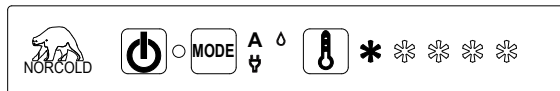
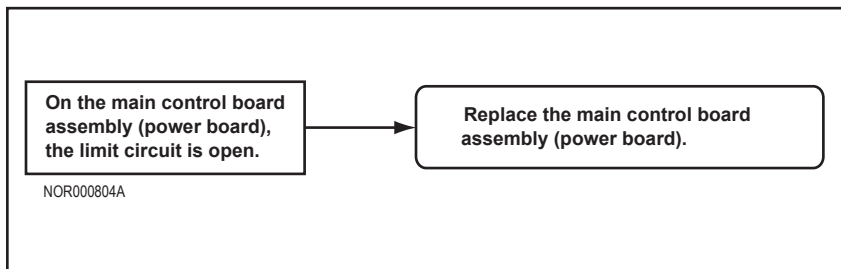

Red, flashes on three (3) times, is off five (5) seconds, repeats.

### Possible Cause:

On the main control board assembly (power board), the limit circuit is open.

## Fault Code - Flash Pattern 4

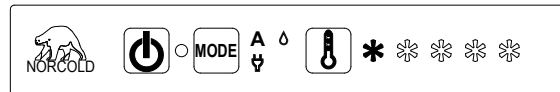
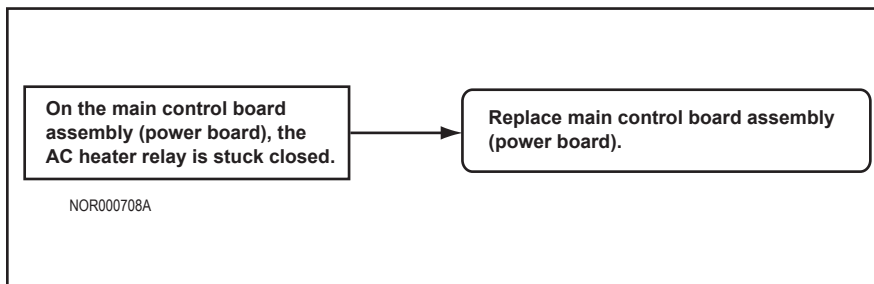

Red, flashes on four (4) times, is off five (5) seconds, repeats.

### Possible Cause:

On the main control board Assembly (power board), the AC heater relay is stuck closed.



## Fault Code - Flash Pattern 5

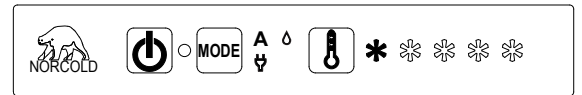
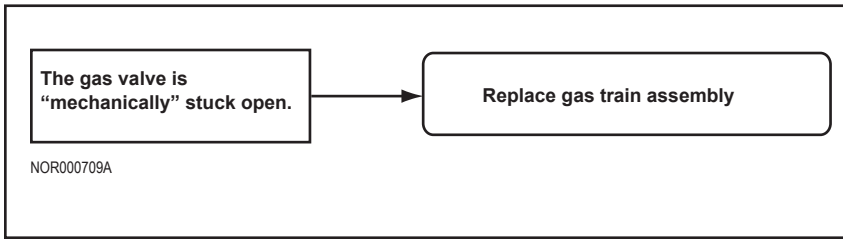

Red, flashes on five (5) times, is off five (5) seconds, repeats.

A flame is sensed at the burner when there should be none present.

**Possible Cause:**

The gas valve is “mechanically” stuck open. Therefore, the main control board senses a flame is present at the burner when there should be none

## Fault Code - Flash Pattern 8

Correct the DC input voltage to the refrigerator. Make sure the input voltage is 12.0 VDC.

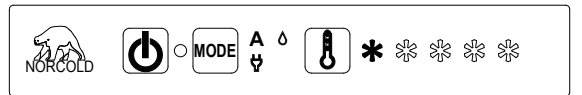

Red, flashes on eight (8) times, is off five (5) seconds, repeats.

**Possible Cause:**

The DC input voltage to the refrigerator is too low.

## Fault Code - Flash Pattern 9

Correct the DC input voltage to the refrigerator. Make sure the input voltage is 12.0 VDC.

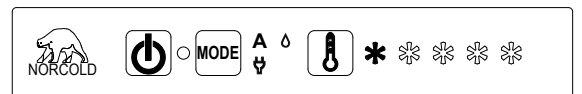

Red, flashes on nine (9) times, is off five (5) seconds, repeats.

**Possible Cause:**

The DC input voltage to the refrigerator is too high.

## Fault Code - Flash Pattern 10

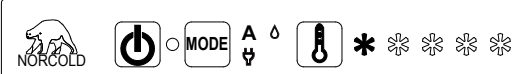
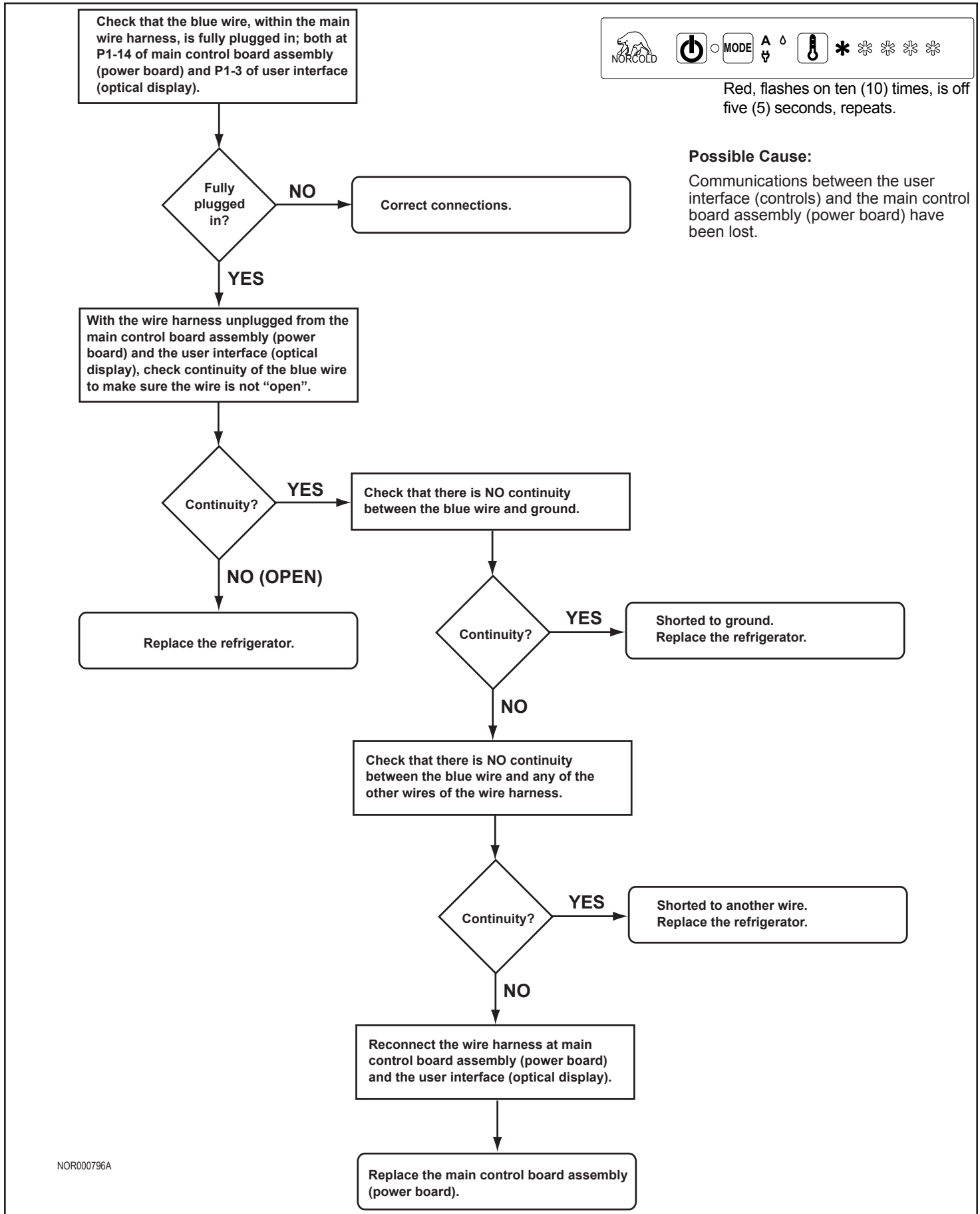

Red, flashes on ten (10) times, is off five (5) seconds, repeats.

**Possible Cause:**

Communications between the user interface (controls) and the main control board assembly (power board) have been lost.

NOR000796A

## Fault Code - Thermistor Fault

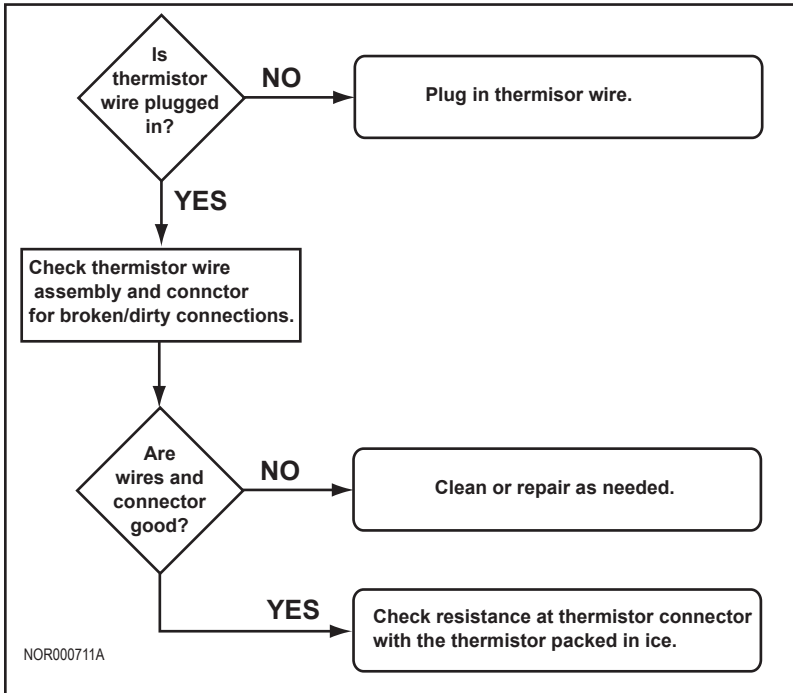

Temperature setting snowflake(s) flash on/off at one (1) second intervals anytime the user interface (control) is "awake".

**Possible Cause:**

The thermistor has been sensed as inoperable, so temperature is being controlled via backup operating system.

Temperature* (°F)	Resistance* (k Ω)
85	8.1 - 9.0
80	9.1 - 10.0
75	10.1 - 11.0
70	11.1 - 12.0
60	12.1 - 13.0
50	15.5 - 16.5
40	22.5 - 23.5
35	24.5 - 25.5
33	28.5 - 29.5
32	30.0 - 32.0
* Approximate values	

## Blank Display

Before starting this procedure verify:

- DC voltage to the refrigerator is 10.5 to 16.0 volts.
- No other appliance or lighting circuit is connected to the refrigerator DC circuit.
- DC input of the vehicle is wired into the main control board according to the Refrigerator Installation Manual.

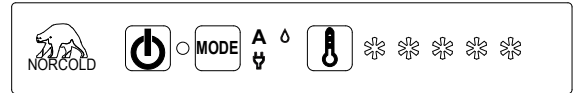

Blank display.

**Possible Cause:**  
The refrigerator is OFF.

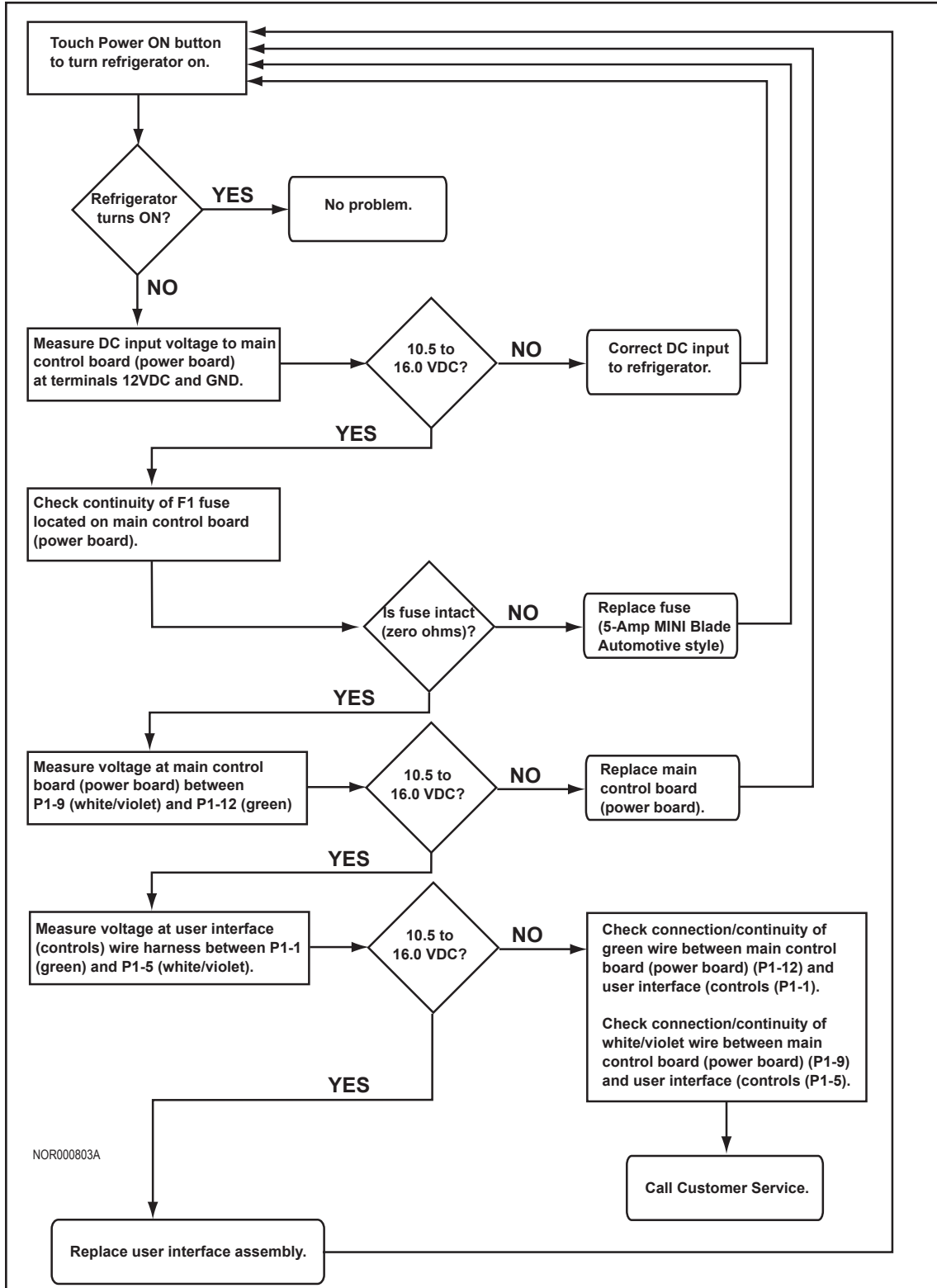

# USER INTERFACE (CONTROLS) - N7LX AND N8LX MODELS

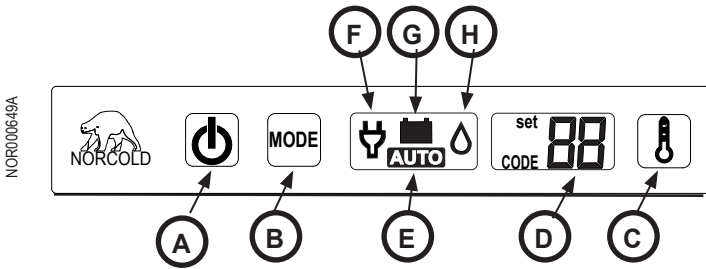

**Fig. 15 - N7LX and N8LX user interface (control locations)**

No.	Description
A	Power ON / OFF Button
B	Mode Button
C	Temperature Set Button
D	LCD Display
E	AUTO Mode Indicator
F	AC Mode Indicator
G	GAS Mode Indicator
H	DC Mode Indicator

## Power ON / OFF Button

Touch and release the Power ON / OFF button (See Fig. 15, A) to turn on the refrigerator.

Touch and hold the Power ON / OFF button for one (1) second to turn off the refrigerator.

## Mode Button

The mode button is manually operated and does not automatically change the operating mode of the refrigerator.

Touch and hold the Mode button (See Fig. 15, B) to scroll through the available modes of operation of the refrigerator, one after the other. When the desired mode indicator comes on, release the Mode button.

Or touch and release the Mode button to change the available modes of operation one at a time. There are one (1) Automatic and two (2) Manual Modes of operation on 2-way models and one (1) Automatic and three (3) Manual Modes of operation on 3-way models.

- **AUTO Mode:** The AUTO Mode indicator (See Fig. 15, E) comes on and the refrigerator controls automatically select the most efficient energy source that is available.
  - The first choice of operation is AC electric. If available, the refrigerator controls select AC electric as the power choice and the AC mode indicator comes on also (See Fig. 15, F).

- If AC electric is not available to the refrigerator, if the AC electric is outside the permitted operating range, or if the AC heater does not operate, the electronic controls of the refrigerator automatically change to the second choice of operation.

- The second choice of operation is propane gas. If AC electric is not available, the controls select gas as the power choice.
- If unable to establish and maintain a flame, a “no” FL” fault code shows on the LCD display (See Fig. 15, D). Refer to the “Fault Codes - N7LX and N8LX Models” section.
- On 3-way models only, if neither AC electric nor gas is available, the controls select DC electric as the power choice the DC mode indicator (See Fig. 15, H) comes on also.
  - If the DC heater does not operate, the “dc” HE” fault code shows on the LCD.

- **MANUAL AC mode:** The refrigerator operates using only AC electric as the power source and the AC mode indicator comes on.
- **MANUAL GAS mode:** The refrigerator operates using only gas as the power source and the GAS mode indicator comes on.
- **MANUAL DC mode (3-way models only):** The refrigerator operates using only DC electric as the power source and the DC mode indicator comes on.

## Temperature Set Button

Touch and release the Temperature Set button (See Fig. 15, C) to view the current temperature setting.

There are nine (9) temperature settings which appear as numbers in the LCD display.

- Number one (1) is the warmest temperature setting.
- Number nine (9) is the coldest temperature setting.

Touch and hold the Temperature Set button to scroll through temperature settings, one after the other. Release the Temperature Set button when the desired temperature setting appears.

Or touch and release the Temperature Set button to change the temperature settings, one at a time.

## Gas Operation

When either AUTO or MANUAL GAS mode is selected, the refrigerator attempts to ignite the propane gas burner. If unable to ignite the burner and to maintain a flame, the fault code “no” “FL” appears in the LCD display.

## Gas Mode

In AUTO GAS mode and MANUAL GAS mode, the controls energize the solenoid coil to open the gas valve. Spring pressure closes the valve when the controls stop the flow of current to the solenoid coil.

The propane gas burner will cycle in response to the fin temperature to maintain cabinet temperature.

The controls use an electronic sparker to ignite the propane gas at the burner.

## AC Mode

AUTO AC or MANUAL AC mode operation requires 108 to 132 volts AC. Voltage is to be supplied through a 2 pole, 3-wire, 20 Amp grounding type receptacle.

A 120 volt AC heater generates the heat load required for AUTO AC and Manual AC operation. To replace the heater, the refrigerator must be removed from the enclosure.



Burn hazard! Allow canister and heaters to cool before attempting to remove and replace.

The AC electric heater will cycle in response to the fin temperature to maintain the cabinet temperature.

## DC Mode (3-way models only)

AUTO DC or MANUAL DC mode operation requires 10.5 to 16.0 volts DC.

A 12 volt DC heater generates the heat load required for AUTO DC and Manual DC operation. To replace the heater, the refrigerator must be removed from the enclosure.



Burn hazard! Allow canister and heaters to cool before attempting to remove and replace.

The DC electric heater will cycle in response to the fin temperature to maintain the cabinet temperature.

## Air in the Propane Gas Supply Lines

### NOTICE

For safety reasons, the refrigerator electronic controls are designed so that while operating in Propane Gas Mode, the trial for ignition (the maximum time that the gas valve and the igniter can be left on without a flame present) is limited to 30 seconds. When starting the refrigerator for the first time, after storage, or after replacing the propane gas tanks(s), the propane gas supply lines can have air in them.

Due to the air in the gas supply lines, the burner may not ignite within the 30 second time limit. If this happens, the gas valve and igniter outputs will be turned off, the propane gas mode will be "locked out," and the appropriate fault code will show in the display.









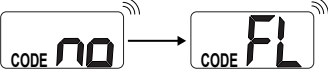
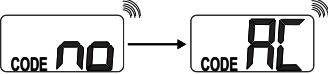
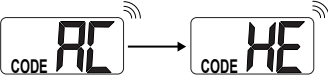
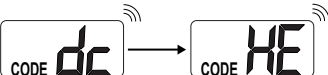

The gas lock out condition can be reset by powering the refrigerator OFF and back ON, at which time a new 30 second trial for ignition will begin. You may need to repeat this procedure several times to remove all of the air from the gas supply lines.



## Diagnostic Pre checks

Diagnosing fault codes begins by starting with the basics. In many cases, the problem can be solved by verifying the unit is operating in acceptable conditions:

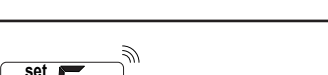
- The refrigerator is plugged into a known working AC outlet with a voltage between 108VAC and 132VAC
- Extension cords are not being used to supply AC power to the refrigerator
- The refrigerator is connected to a known working DC power supply and/or battery supplying between 10.5 and 16.0 VDC
- Propane gas is available to the refrigerator and is regulated between 10.5 and 11.5" WC (Inches of Water Column).

# FAULT CODES - N7LX AND N8LX MODELS

Fault Code	Fault Code Meaning	Action to Take
NOR000650-  <p>Alternately flashes “no” and “FL” with an audible alarm.</p>	The burner did not ignite or re-ignite.	Refer to “Fault Code - “no” “FL” with audible alarm” on page 40.
 <p>Alternately flashes “no” and “AC” with an audible alarm.</p>	AC voltage is not available to the refrigerator.	Refer to “Fault Code - “no” “AC” with audible alarm” on page 42.
 <p>Alternately flashes “AC” and “HE” with an audible alarm.</p>	AC heater fault.	Refer to “Fault Code - “AC” “HE” with audible alarm” on page 43.
 <p>Alternately flashes “dc” and “HE” with an audible alarm.</p>	DC heater fault.	Refer to “Fault Code - “dc” “HE” with audible alarm” on page 44.
 <p>Alternately flashes “AC” and “rE” with an audible alarm.</p>	AC heater relay stuck on.	Refer to “Fault Code - “AC” “rE” with audible alarm” on page 44.
 <p>Alternately flashes “dc” and “rE” with an audible alarm.</p>	DC heater relay stuck on.	Refer to “Fault Code - “dc” “rE” with audible alarm” on page 44.
 <p>Alternately flashes “Lo” and “dc”.</p>	DC input voltage to the refrigerator is low. Cooling is to continue.	Refer to “Fault Code - “Lo” “dc” on page 45.
 <p>Alternately flashes “Lo” and “dc” with an audible alarm.</p>	DC input voltage to the refrigerator is too low. Either the GAS MODE or the DC MODE (3-way models only), or both, is inhibited. The refrigerator is not cooling.	Refer to “Fault Code - “Lo” “dc” with audible alarm” on page 45.
 <p>Alternately flashes “Lo” and “dC” with an audible alarm.</p>	DC input voltage to the refrigerator is too low. All MODES are inhibited.	Refer to “Fault Code - “Lo” “dC” with audible alarm” on page 45.
 <p>Alternately flashes “HI” and “dc” with an audible alarm.</p>	DC input voltage to the refrigerator is too high.	Refer to “Fault Code - “HI” “dc” with audible alarm” on page 45.
 <p>Alternately flashes “no” and “dt” with an audible alarm.</p>	Communications between the controls have been lost.	Refer to “Fault Code - “no” “dt” with audible alarm” on page 46.
 <p>Flashes “Sr” with an audible alarm.</p>	This fault is within the refrigerator controls.	Refer to “Fault Code - “Sr” with audible alarm” on page 47.
 <p>Alternately flashes “oP” and “LI” with an audible alarm.</p>	This fault is within the refrigerator controls.	Refer to “Fault Code - “oP” “LI” with audible alarm” on page 47.
 <p>Alternately flashes “FL” and “--” with an audible alarm.</p>	A flame is sensed at the burner when there should be none present.	Refer to “Fault Code - “FL” “--” with audible alarm” on page 47.

	Temperature setting flashes on/off at one (1) second intervals any time the user interface (control) is "awake".	The thermistor has been sensed as inoperable, so the temperature is being controlled via backup operating system.	Refer to "Fault Code - Flashing Temperature Setting" on page 48.
	Blank display.	The refrigeratro will not turn ON.	Refer to "Blank Display" on page 49.

## TROUBLESHOOTING FLOWCHARTS - N7LX AND N8LX MODELS

### Fault Code - "no" "FL" with audible alarm

Before starting this procedure, make sure:

- The valve of the RV propane gas tank(s) is open.
- The manual shut-off valve of the gas train assembly is open.
- The propane gas pressure to the refrigerator is 10.5 inches W.C.

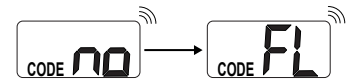
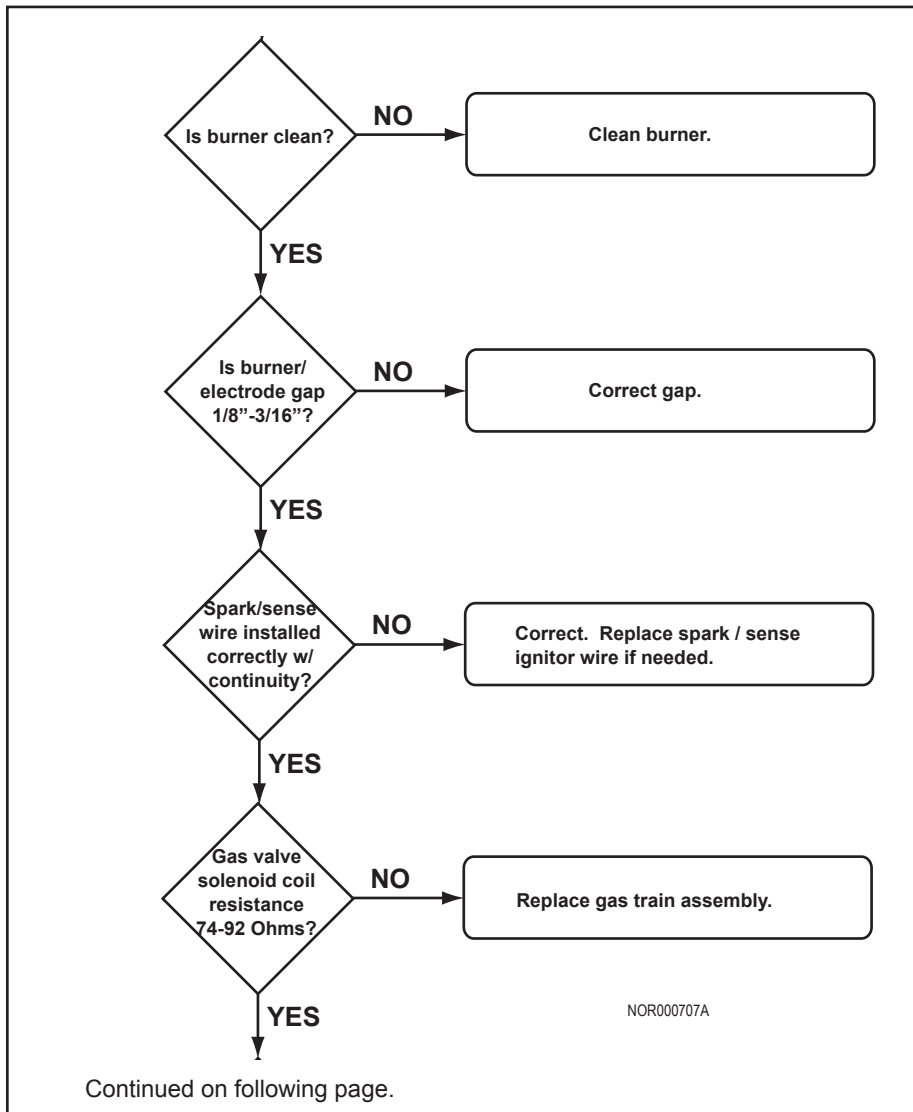

Alternately flashes "no" and "FL" with an audible alarm.

**Possible Cause:**

No flame is sensed present at the burner when there should be one.

The burner did not ignite or re-ignite.

This fault can occur in AUTO MODE or MANUAL GAS MODE



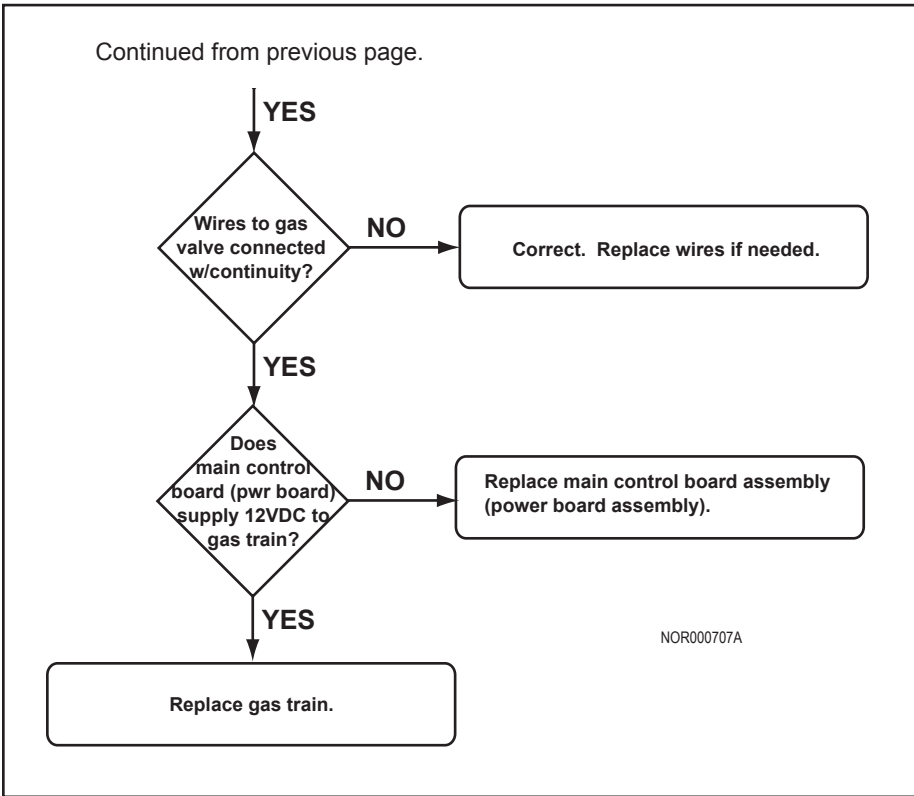

## Fault Code - "no" "AC" with audible alarm

Before starting this procedure make sure:

- No other problems exist with the vehicle's AC power supply.
- No other appliances or lighting circuits are connected to the refrigerator AC circuit.
- No extension cords are being used to supply AC power to the refrigerator.

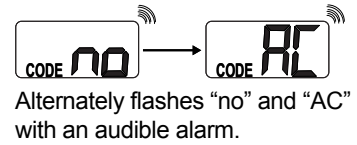

**Possible Cause:**

There is no AC power to the refrigerator.

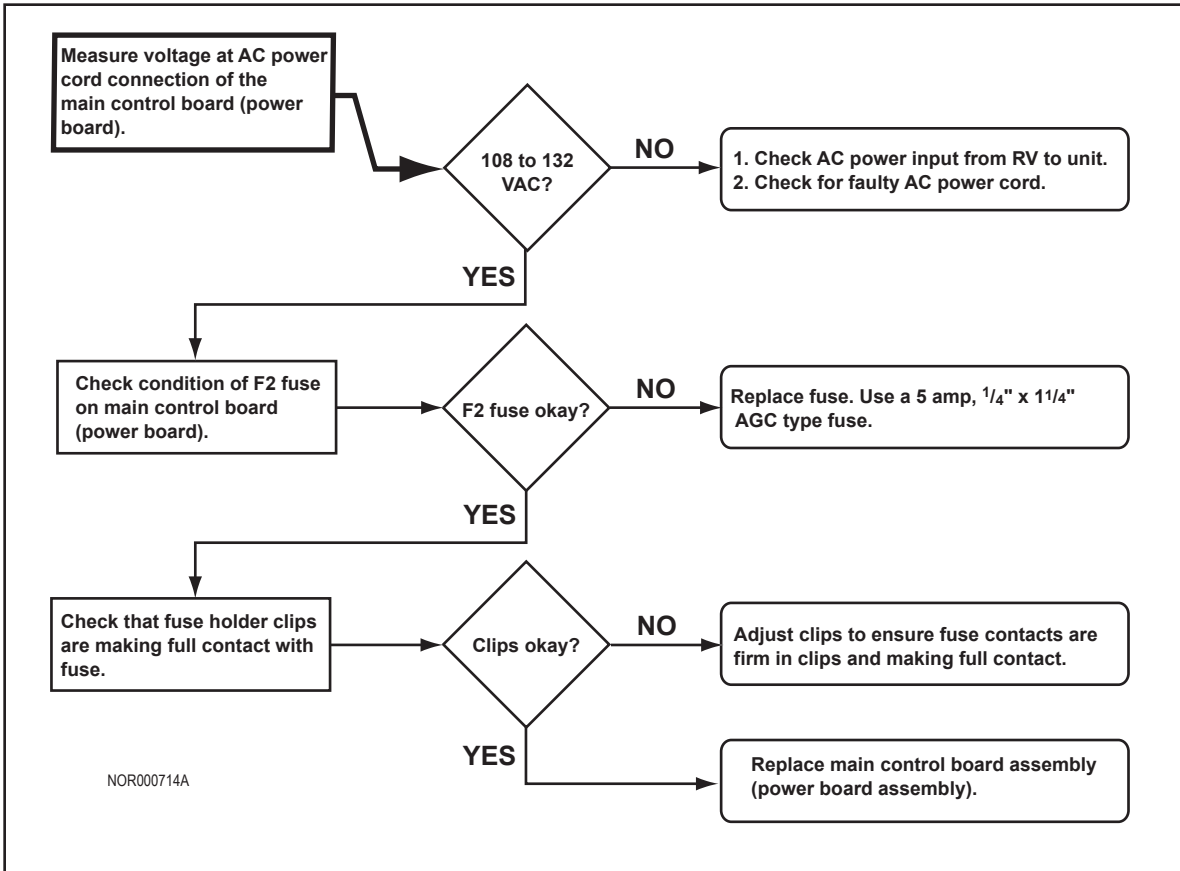

## Fault Code - "AC" "HE" with audible alarm

Before starting this procedure make sure:

- The AC voltage to the refrigerator is 108-132 VAC.
- No other appliance or lighting circuit is connected to the refrigerator AC circuit.

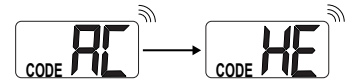

Alternately flashes "AC" and "HE" with an audible alarm.

The AC is off when it should be on. AC heater "lockout." Turn the refrigerator OFF and then back ON to reset.

**Possible Cause:**

- AC heater fault.
- The AC heater is not plugged in.
- The AC heater failed open.

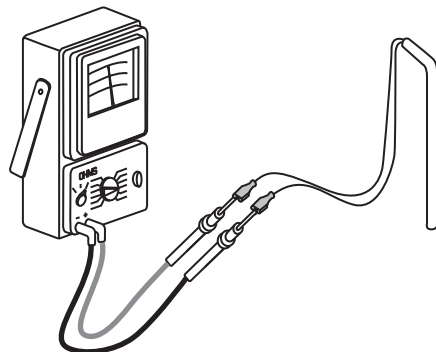
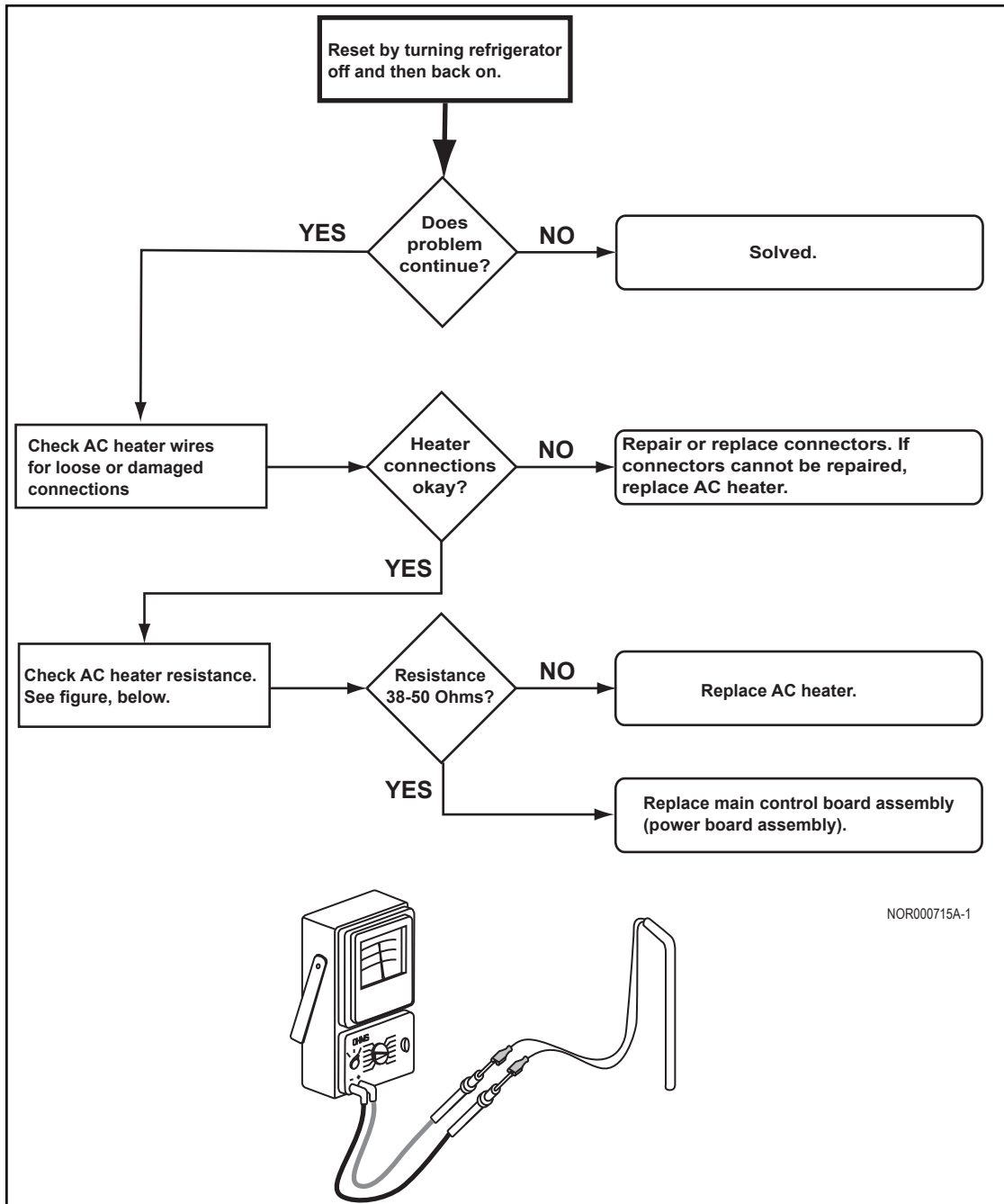

NOR000715A-1

### Fault Code - "dc" "HE" with audible alarm

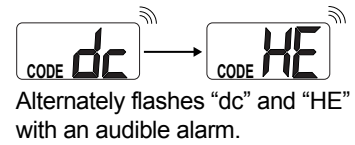
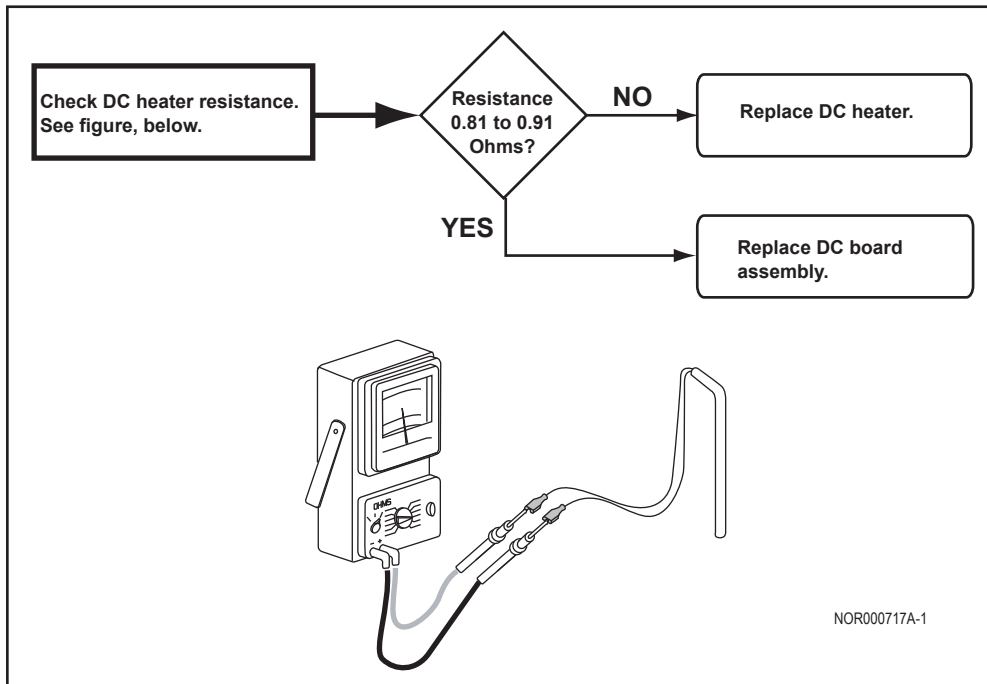

**Possible Cause:**

The DC heater has failed (3-way models only).

### Fault Code - "AC" "rE" with audible alarm

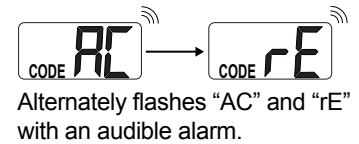
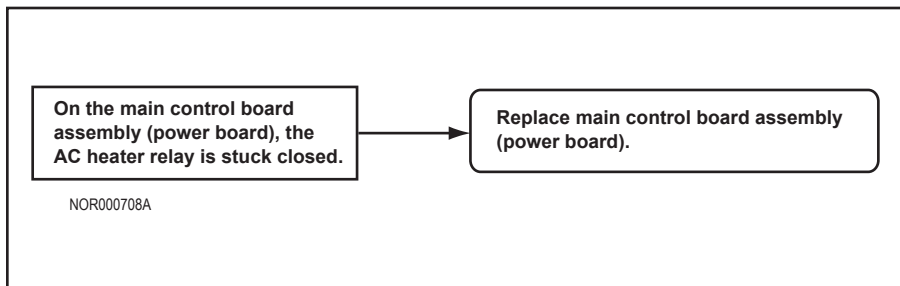

**Possible Cause:**

On the main control board assembly (power board), the AC heater relay is stuck closed. This fault can be displayed in ANY MODE

### Fault Code - "dc" "rE" with audible alarm

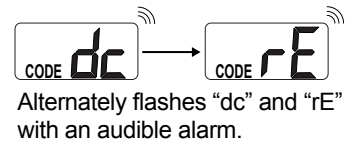
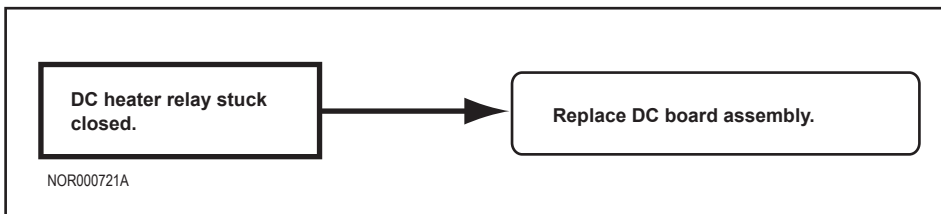

**Possible Cause:**

The contacts of DC heater relay (K1 on the DC Board) are stuck closed. This fault can be displayed in ANY MODE.

### Fault Code - "Lo" "dc"

Correct the DC input voltage to the refrigerator. Make sure the input voltage is 12.0 VDC.

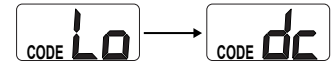

Alternately flashes "Lo" and "dc".

**Possible Cause:**

The DC input voltage to the refrigerator is too low.

### Fault Code - "Lo" "dc" with audible alarm

Correct the DC input voltage to the refrigerator. Make sure the input voltage is 12.0 VDC.

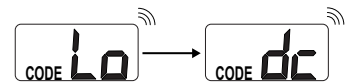

Alternately flashes "Lo" and "dc" with an audible alarm.

**Possible Cause:**

The DC input voltage to the refrigerator is too low.

### Fault Code - "Lo" "dC" with audible alarm

Correct the DC input voltage to the refrigerator. Make sure the input voltage is 12.0 VDC.

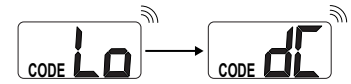

Alternately flashes "Lo" and "dC" with an audible alarm.

**Possible Cause:**

DC input voltage to the refrigerator is too low.

### Fault Code - "HI" "dc" with audible alarm

Correct the DC input voltage to the refrigerator. Make sure the input voltage is 12.0 VDC.

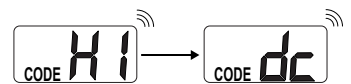

Alternately flashes "HI" and "dc" with an audible alarm.

**Possible Cause:**

The DC input voltage to the refrigerator is too high.

**Fault Code - "no" "dt" with audible alarm**

Check that the blue wire, within the main wire harness, is fully plugged in; both at P1-14 of main control board assembly (power board) and P1-3 of user interface (optical display).

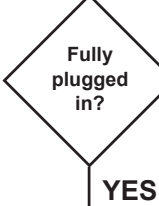

Correct connections.

With the wire harness unplugged from the main control board assembly (power board) and the user interface (optical display), check continuity of the blue wire to make sure the wire is not "open".



Check that there is NO continuity between the blue wire and ground.

Replace the refrigerator.



Shorted to ground. Replace the refrigerator.

Check that there is NO continuity between the blue wire and any of the other wires of the wire harness.



Shorted to another wire. Replace the refrigerator.

Reconnect the wire harness at main control board assembly (power board) and the user interface (optical display).

Replace the main control board assembly (power board).

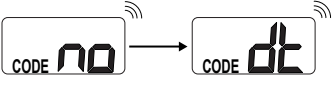

Alternately flashes "no" and "dt" with an audible alarm.

**Possible Cause:**

Communications between the user interface (controls) and the main control board assembly (power board) have been lost.

NOR000796A

### Fault Code - "Sr" with audible alarm

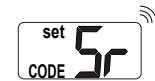
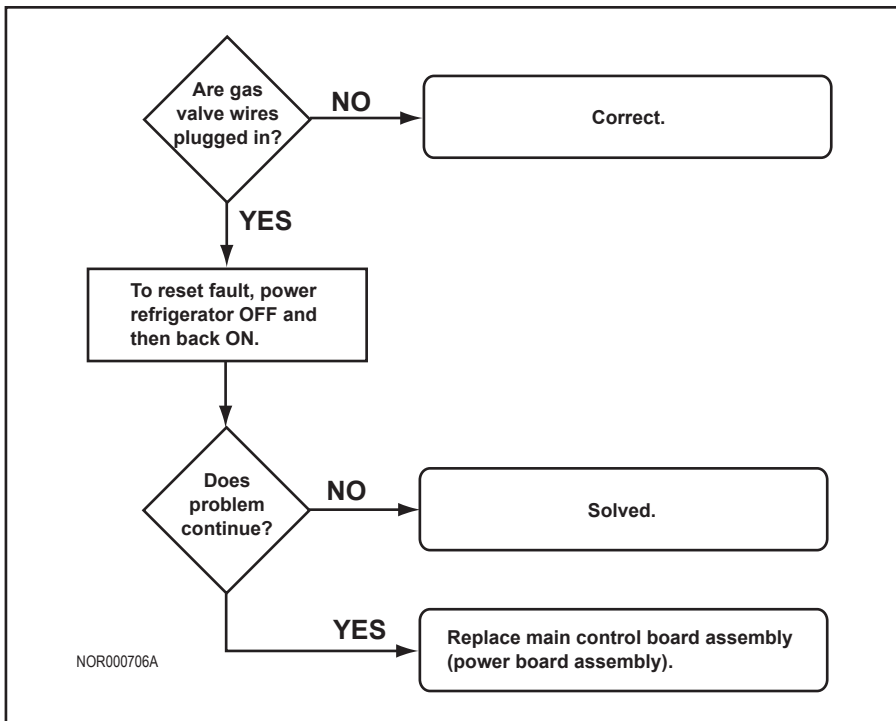

Flashes "Sr" with an audible alarm.

**Possible Cause:**

The main control board assembly (power board) detected an internal fault. This fault can be displayed in any MODE.

### Fault Code - "oP" "LI" with audible alarm

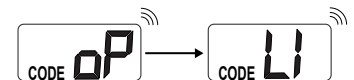
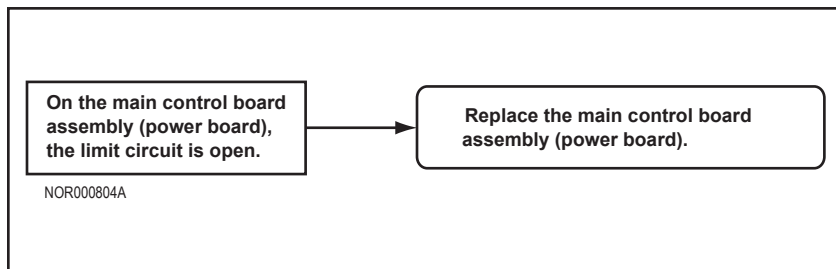

Alternately flashes "oP" and "LI" with an audible alarm.

**Possible Cause:**

On the main control board assembly (power board), the limit circuit is open.

### Fault Code - "FL" "- -" with audible alarm

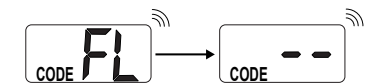
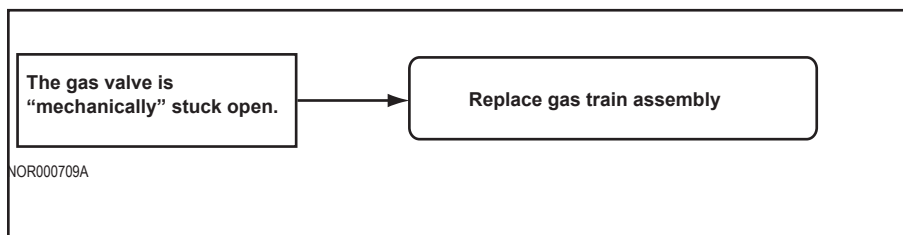

Alternately flashes "FL" and "- -" with an audible alarm.

A flame is sensed at the burner when there should be none present.

**Possible Cause:**

The gas valve is "mechanically" stuck open. Therefore, the main control board (power board) senses a flame is present at the burner when there should be none

## Fault Code - Flashing Temperature Setting

A flashing temperature setting indicator means the electronic controls have sensed the fin thermistor to be inoperable. This fault is only displayed while the optical display is "awake." To "wake" the display press and release either the Mode or Temperature Set buttons. If there is a problem sensed with the thermistor the temperature setting icon will flash ON and OFF. After 10-seconds the control will revert back to the "sleep" mode. This fault can be displayed in ANY MODE.

Should the thermistor be sensed inoperable the electronic controls will ignore the thermistor and revert to a BOS mode (Backup Operating System). The BOS mode is an electronically controlled duty cycle that allows the refrigerator to continue operating until such time the thermistor can be repaired or replaced.

This duty cycle will maintain refrigerator cooling by controlling the length of time the heat source outputs (AC heater and propane gas burner) are energized. The duty cycle, or length of time the cooling cycle is regulated, can be manually controlled via the Temperature Set button.

When a colder temperature is desired, changing the temperature setting to the next "colder" setting will provide additional cooling by lengthening the cooling cycle. For example, if the temperature setting is set to 5, adjusting the temperature setting to the next colder setting of 6 will lengthen the cooling cycle. When a warmer temperature is desired, changing the temperature setting to a warmer setting shortens the cooling cycle. For example, if the temperature setting is set to 4, lowering the setting to 3 will shorten the cooling cycle.

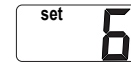
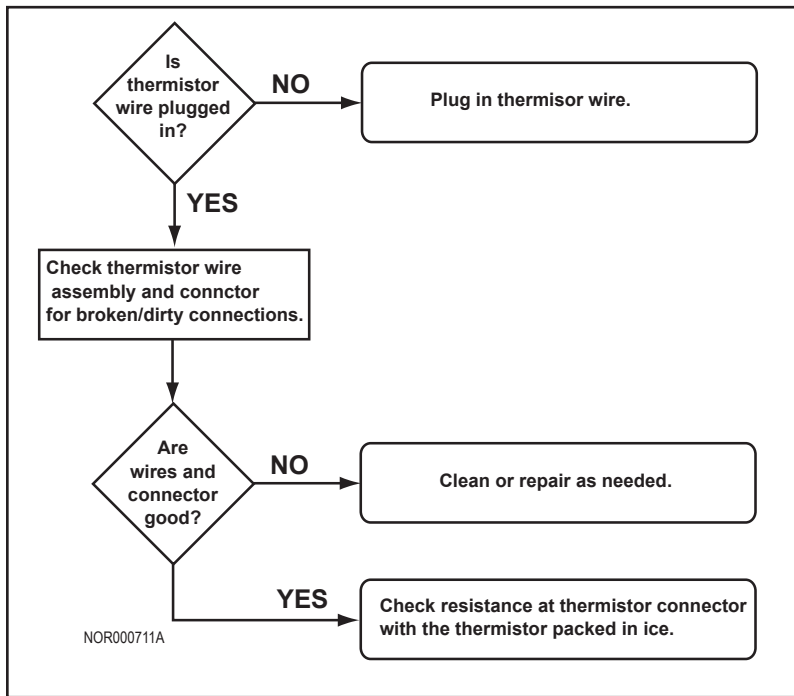

Temperature setting flashes on/off at one (1) second intervals any time the user interface (control) is "awake".

### Possible Cause:

The thermistor has been sensed as inoperable, so temperature is being controlled via backup operating system.

## NOTICE

An alternate method would be to use an infrared gun to measure the fin temperature. Then compare that temperature with the temperature indicated on Diagnostic Screen #3. The temperature difference should be 6° F or less. If not, thermistor is bad.

Temperature* (°F)	Resistance* (k Ω)
85	8.1 - 9.0
80	9.1 - 10.0
75	10.1 - 11.0
70	11.1 - 12.0
60	12.1 - 13.0
* Approximate values	

Temperature* (°F)	Resistance* (k Ω)
50	15.5 - 16.5
40	22.5 - 23.5
35	24.5 - 25.5
33	28.5 - 29.5
32	30.0 - 32.0
* Approximate values	



## Blank Display

Before starting this procedure:

- Make sure the vehicle DC voltage to the refrigerator is 10.5 to 16.0 volts.
- Make sure no other appliance or lighting circuit is connected to the refrigerator DC circuit.
- Make sure the DC input of the vehicle is wired into the main control board according to the Refrigerator Installation Manual.



Blank display.

**Possible Cause:**

The refrigerator is OFF.

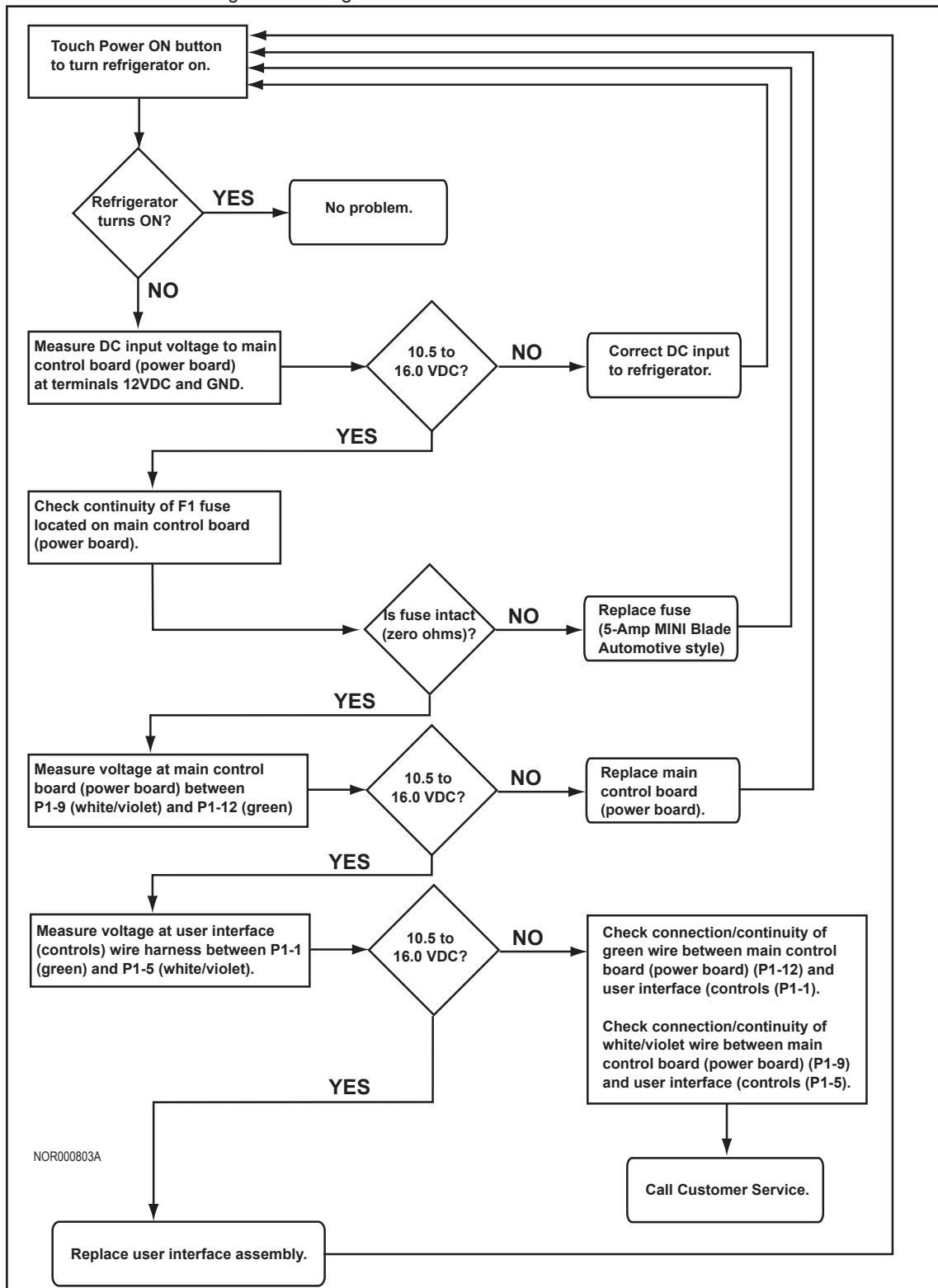

NOR000803A

# DIAGNOSTIC MODE - N7LX AND N8LX MODELS

## General Diagnostic Information

The diagnostic mode is a tool incorporated within the controls and can be accessed via the optical display. This tool is designed to assist in verifying temperature, inputs, outputs, and to retrieve recorded faults stored by the controls by displaying the various information via the LCD. Ten (10) screens, each having a particular function, are used to display this information. For example, screen three (3) displays the fresh food fin thermistor temperature, and screens four (4) and five (5) display stored fault history.

The LCD utilizes a dual 7-segment display within the LCD. The screen number is displayed utilizing the left-side 7-segment display while inputs, outputs, and various fault related information is displayed utilizing individual segments of the right-side 7-segment display. These individual segments will be defined/explained under each of the individual screen descriptions to follow.

## Access Diagnostic Mode

1. Touch and hold both the MODE and the Temperature Set buttons at the same time for five (5) seconds.
2. Release the MODE and the Temperature Set buttons as soon as Screen 1, Initial view appears.
3. A few seconds later, Screen 1, Second view appears.

## Change Screens

To change screens, press and hold the MODE button until the next screen displays.

## Exit Diagnostic Mode

1. Touch and hold both the MODE and the Temperature Set buttons at the same time for two (2) seconds.
2. Release the MODE and the Temperature Set buttons when the mode icons and temperature setting once again display.

Turning the refrigerator OFF then back ON also exits the Diagnostic Mode.

## Screens and Diagnostic Segments Information

### SCREEN 1: All Diagnostic Icons ON

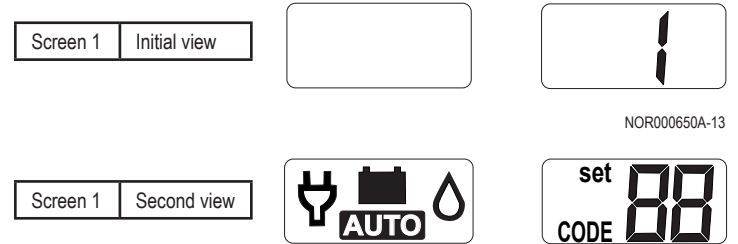

- Verifies all icons are operational by turning them on.

### SCREEN 2: All Diagnostic Icons OFF

Touch and release the MODE button to bring up screen 2.

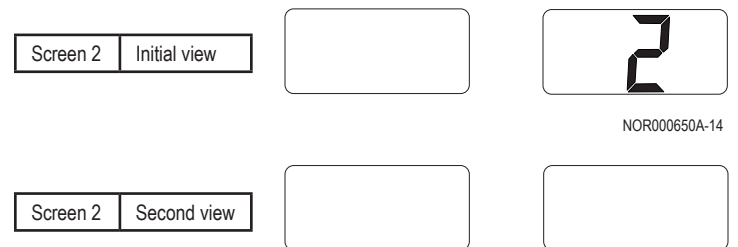

- Verifies all icons are operational by turning them off.

### SCREEN 3: Fresh Food Fin Temperature

Touch and release the MODE button to bring up screen 3.

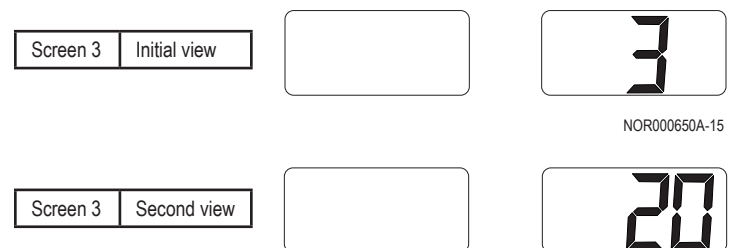

This screen displays the actual fin temperature being sensed by the thermistor. ***This is not the fresh food cabinet air temperature.*** The example shows the fin temperature to be 20°F.

- If the thermistor is "open," the second view will show "00".
- If the thermistor is "shorted," the second view will show "99".

### SCREEN 4: Stored Fault History

Touch and release the MODE button to bring up screen 4.

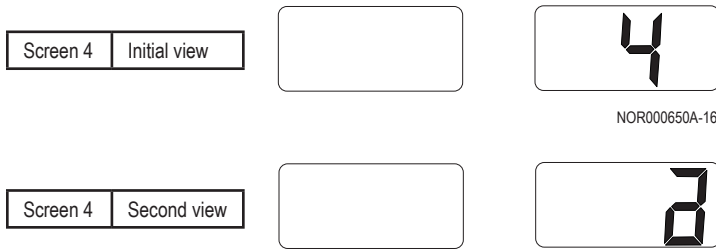

This screen displays stored fault history using lighted LED segments. Refer to illustration below for fault history definitions of the individual LED segments. **If a fault occurred, its assigned fault history LED segment will be on.**

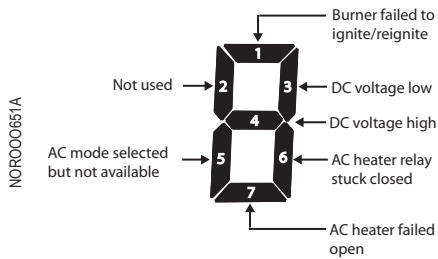

### SCREEN 5: Stored Fault History

Touch and release the MODE button to bring up screen 5.

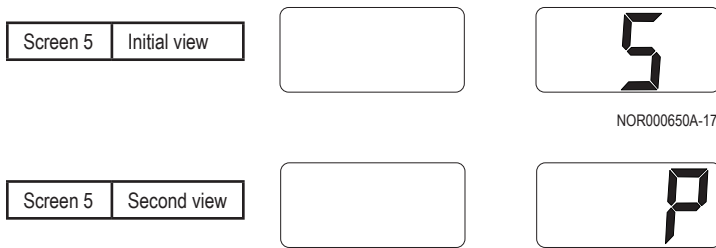

This screen also displays stored fault history using lighted LED segments. Refer to illustration below for fault history definitions of the individual LED segments. **If a fault occurred, its assigned fault history LED segment will be on.**

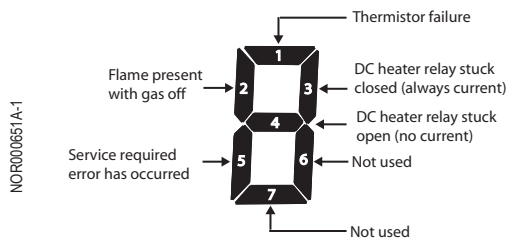

### SCREEN 6: Erasing Fault History

Touch and release the MODE button to bring up screen 6.

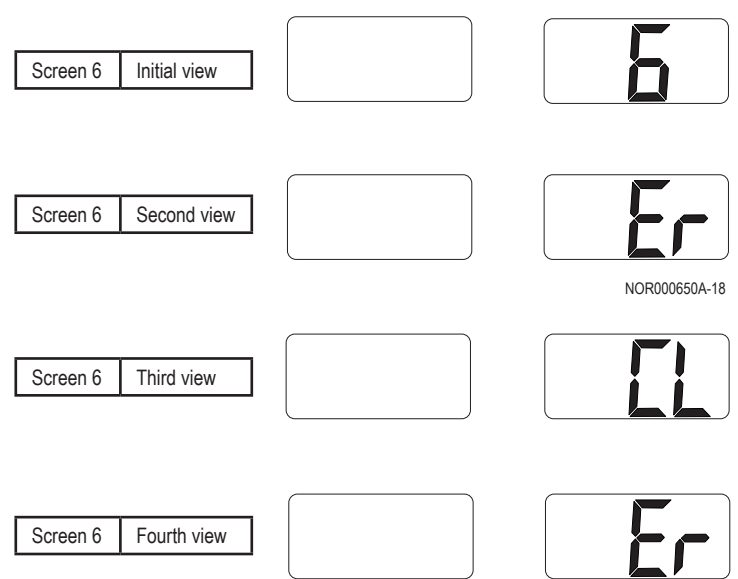

This screen provides a way to erase fault history from memory. To erase the fault history:

- Touch and hold the Temperature Set button five (5) seconds until "CL" shows on the screen.
- Once "CL" is displayed, release the Temperature Set button.
- Touch and hold Temperature Set button five (5) seconds until "Er" is displayed again. At this point, the fault history has been cleared on both Screen 4 and Screen 5.

### SCREEN 7: Power Board Inputs

Touch and release the MODE button to bring up screen 7.

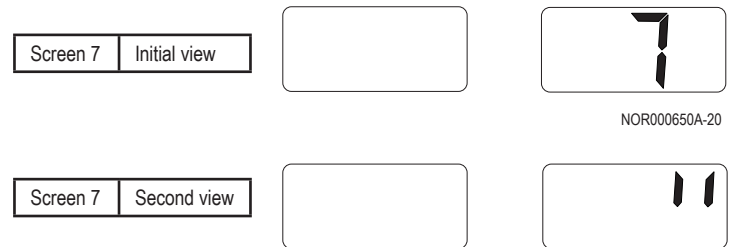

This screen displays "live" power board inputs using lighted LED segments. Refer to illustration below for "live" input definitions of the individual LED segments. **If a power board input is active or "live," its assigned input LED segment will be on.**

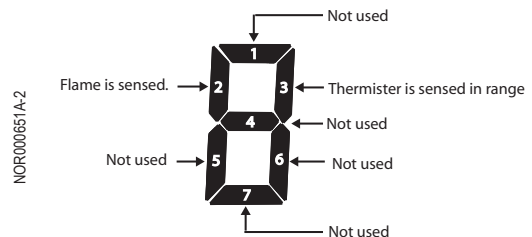

### SCREEN 8. Power Board Outputs

Touch and release the MODE button to bring up screen 8.

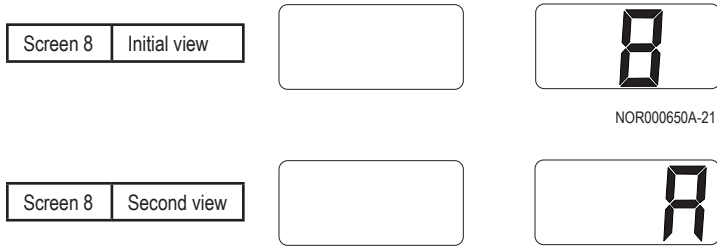

Screen 8 displays “live” power board outputs using lighted LED segments. The following illustration provides definitions of the “live” outputs indicated by the individual LED segments. **If a power board output is active or “live,” its assigned output LED segment will be on.**

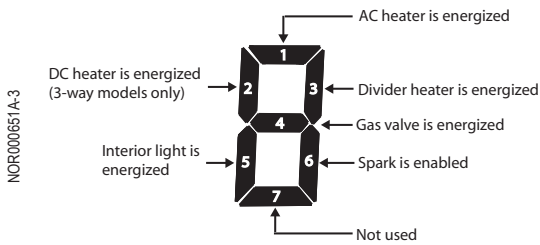

### SCREEN 0. Power Board AC Input Voltage Status

Touch and release the MODE button to bring up screen 0.

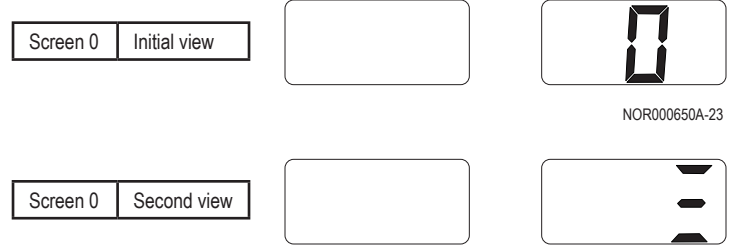

This screen displays AC voltage status using lighted LED segments. Refer to illustration below for definitions of the individual LED segments.

**If AC voltage at the power board is within normal range (85 to 135 VAC), LED segment 4 will be on.**

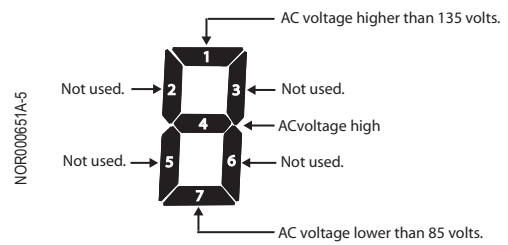

### SCREEN 9. Power Board DC Input Voltage Status

Touch and release the MODE button to bring up screen 9.

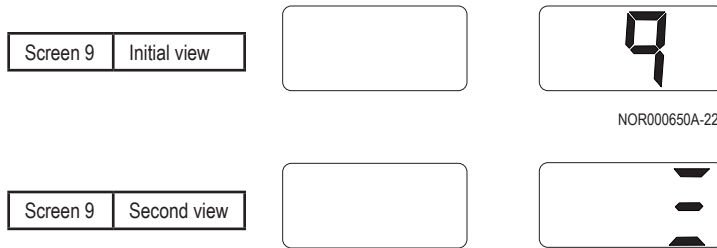

This screen displays DC voltage status using lighted LED segments. Refer to illustration below for definitions of the individual LED segments.

**If DC voltage at the power board is within normal range (10.5 to 16.0 VDC), LED segment 4 will be on.**

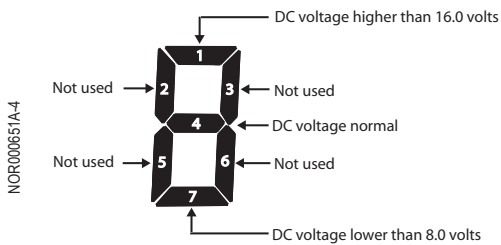

### SCREEN A.

Touch and release the MODE button to bring up screen A.

This screen is not used.

### SCREEN B.

Touch and release the MODE button to bring up screen b.

This screen is not used.

## Cooling System Diagnostic Flowchart



**WARNING** Do not bypass or modify the refrigerator's controls or components to diagnose the cooling system. Do not wire the heater(s) direct. The heater is supplied power through a fused circuit.



**WARNING** Do not operate the refrigerator if the cooling unit is leaking or a leak is suspected.

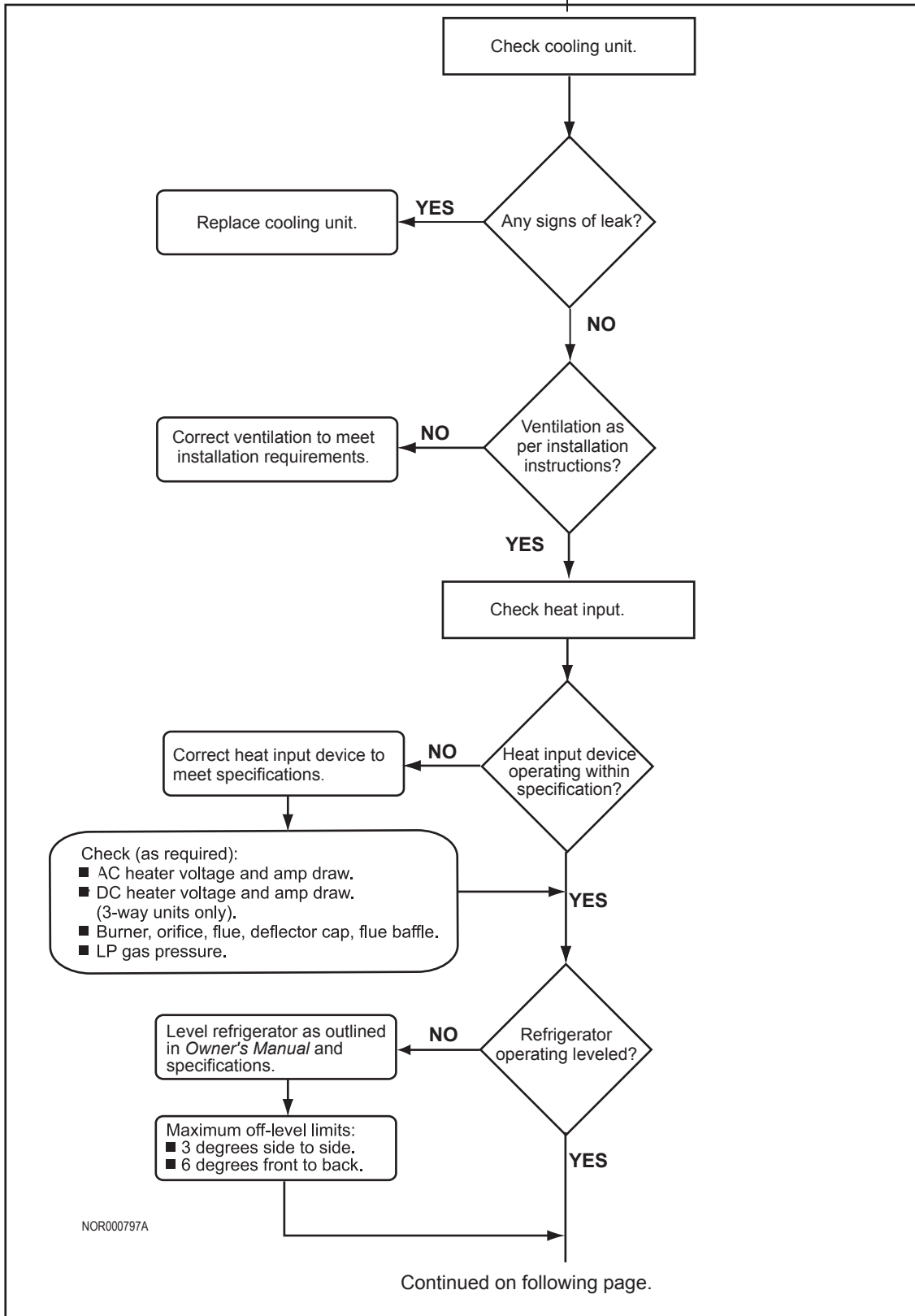

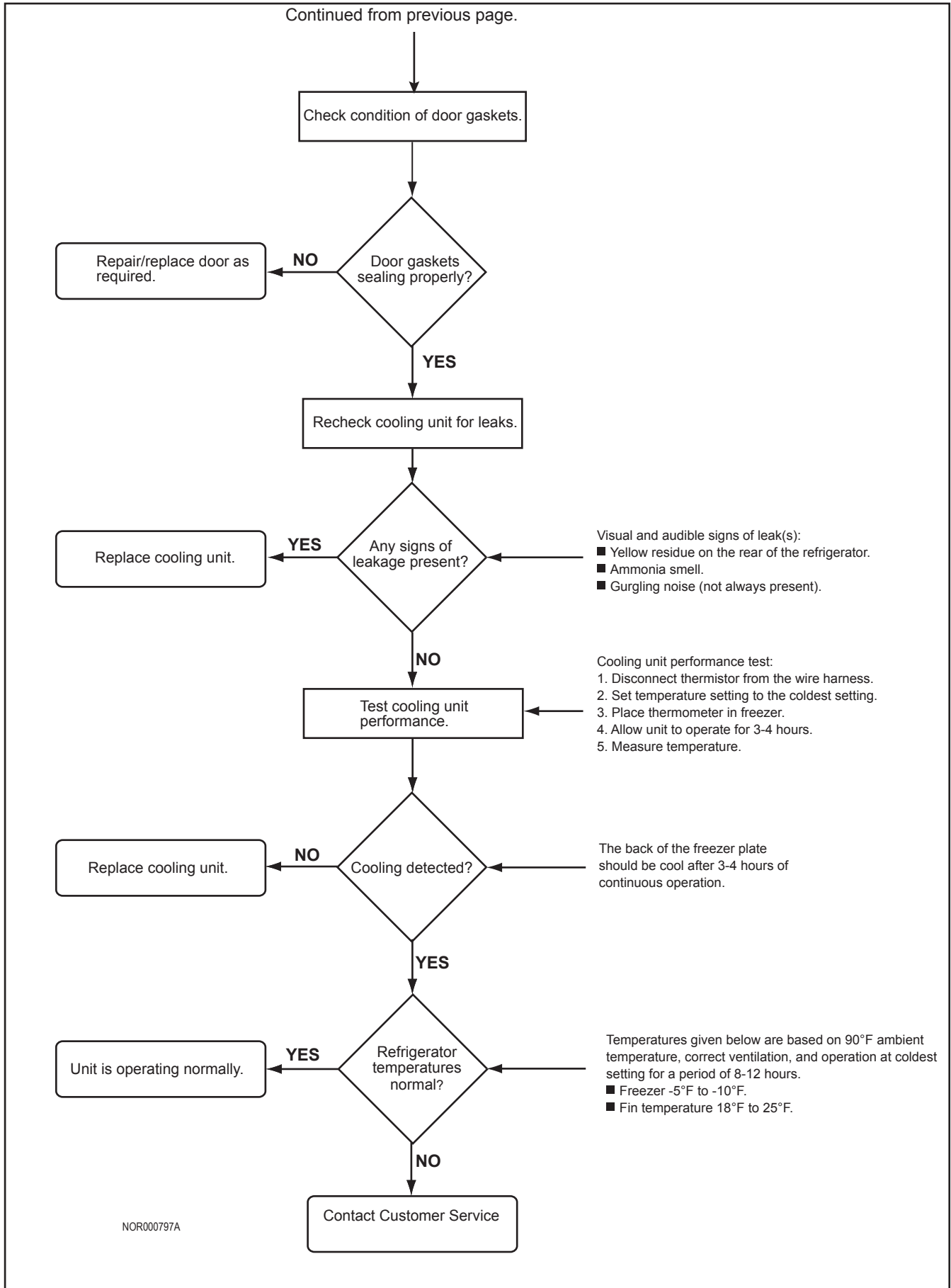

# WIRING SCHEMATIC

	Description
A	Main Control Board (Power Board)
B	AC Power Cord
C	AC Heater
D	Thermostat
E	Water Line Heater
F	Fan
G	Divider Heater
H	Ignitor
J	Gas Valve
K	Fresh Food Thermistor
L	Interior Light
M	User Interface (Control)
N	DC Heater Board
P	DC Heater
R	Cold Weather Heater
S	Freezer Blower
Sw	Switch
T1	Spark Transformer
F1	DC - 5A Control Fuse
F2	DC - 7.5A Auxiliary Fuse
F3	AC - 8A AC Heater Fuse
F1 *	DC - 30A DC Heater Fuse
IM	Ice Maker
AO	Auxiliary Outputs
*	Optional
-----	Optional
	Chassis Ground
TEST	Test Tool Connection
<b>ICE MAKER *</b>	
TF	Thermal Fuse
MH	Mold Heater
TS	Thermostat
SW1	Shut Off Switch
MTR	Motor
SW2	Hold Switch
SW3	Water Fill Switch
WV	Water Valve
L	Line Test Point (120 VAC)
H	Mold Heater Test Point
T	Thermostat Test Point
N	Neutral Test Point
M	Motor Test Point
V	Valve Test Point

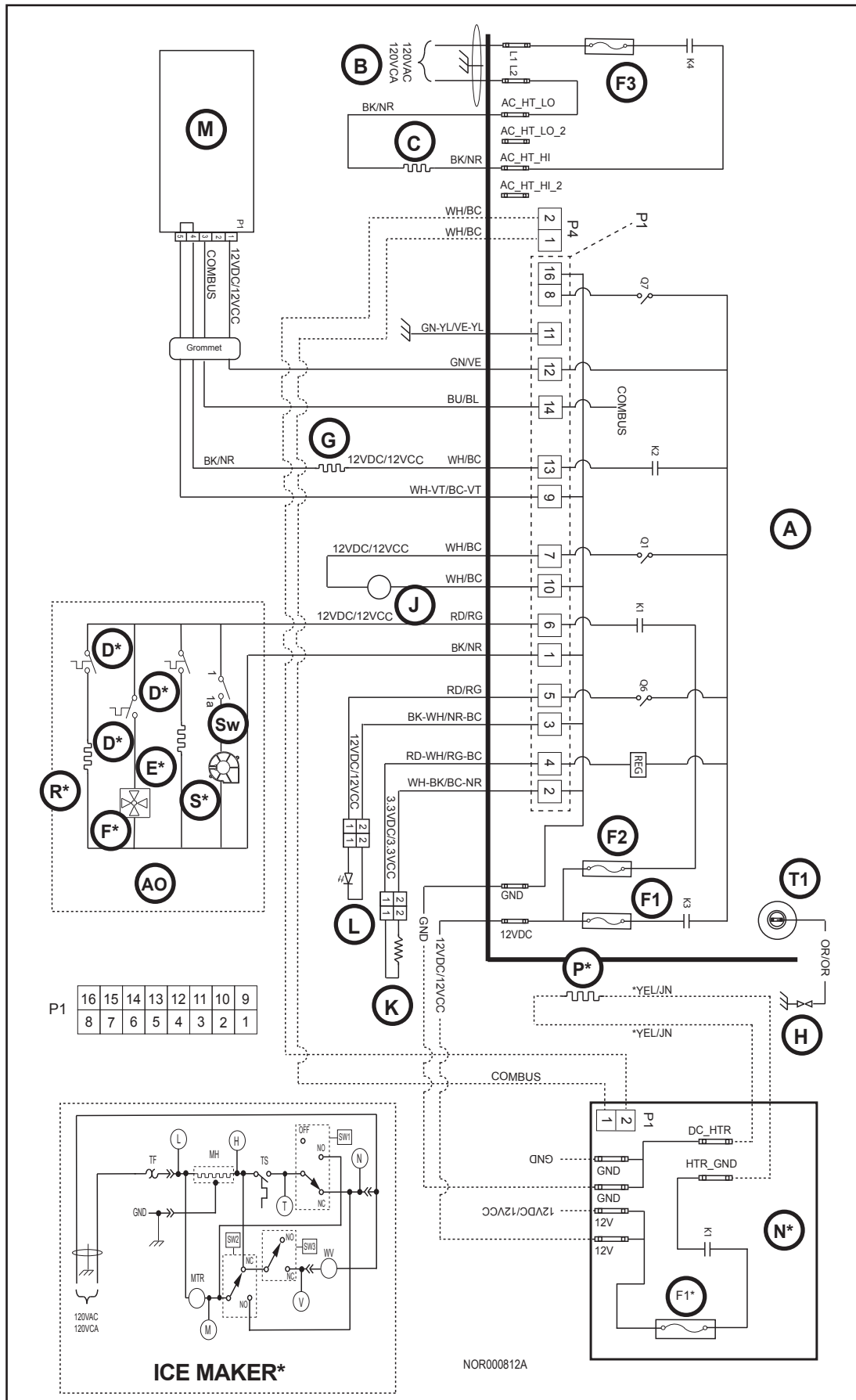

**Fig. 16 - Wiring diagram**

# WIRING PICTORIAL

	Description
A	Main Control Board (Power Board)
B	AC Power Cord
C	AC Heater
D	Thermostat
E	Water Line Heater
F	Fan
G	Divider Heater
H	Ignitor
J	Gas Valve
K	Fresh Food Thermistor
L	Interior Light
M	User Interface (Control)
N	DC Heater Board
P	DC Heater
R	Cold Weather Heater
S	Freezer Blower
Sw	Switch
T1	Spark Transformer
F1	DC - 5A Control Fuse
F2	DC - 7.5A Auxiliary Fuse
F3	AC - 8A AC Heater Fuse
F1*	DC - 30A DC Heater Fuse
*	Optional
----	Optional
	Chassis Ground
<b>ICE MAKER *</b>	
IM*	Ice Maker
TF*	Thermal Fuse
WV*	Water Valve

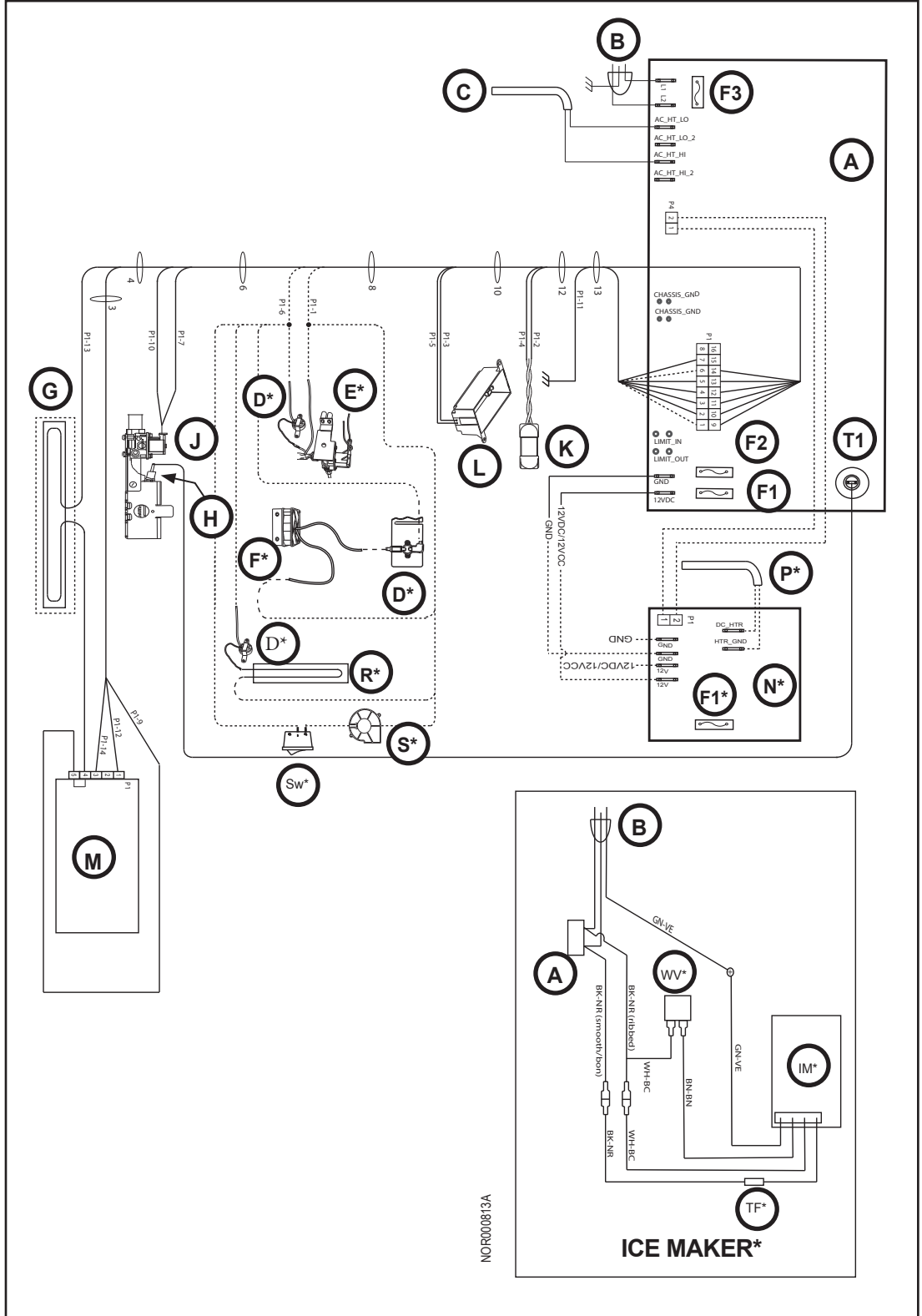

Fig. 17 - Wiring pictorial



# AUXILIARY WIRING CIRCUITS

## Fan Only

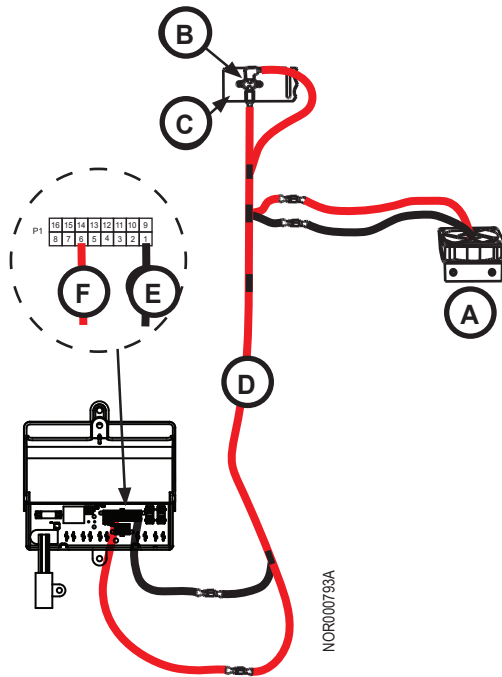

Fig. 18 - Fan only wiring

A	Fan / Bracket Assembly
B	Fan Thermostat
C	Condenser
D	Auxiliary Wire Harness
E	P1-1 Auxiliary 12 VDC (ground)
F	P1-6 Auxiliary 12 VDC (positive)

## Cold Weather Heater Only

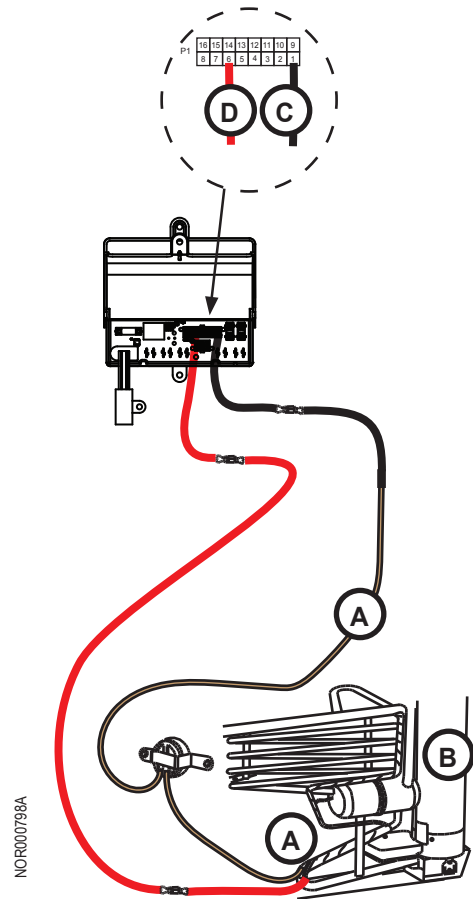

Fig. 19 - Cold weather heater only wiring

A	Cold Weather Heater
B	Cooling Unit
C	P1-1 Auxiliary 12 VDC (ground)
D	P1-6 Auxiliary 12 VDC (positive)

### Fan and Cold Weather Heater

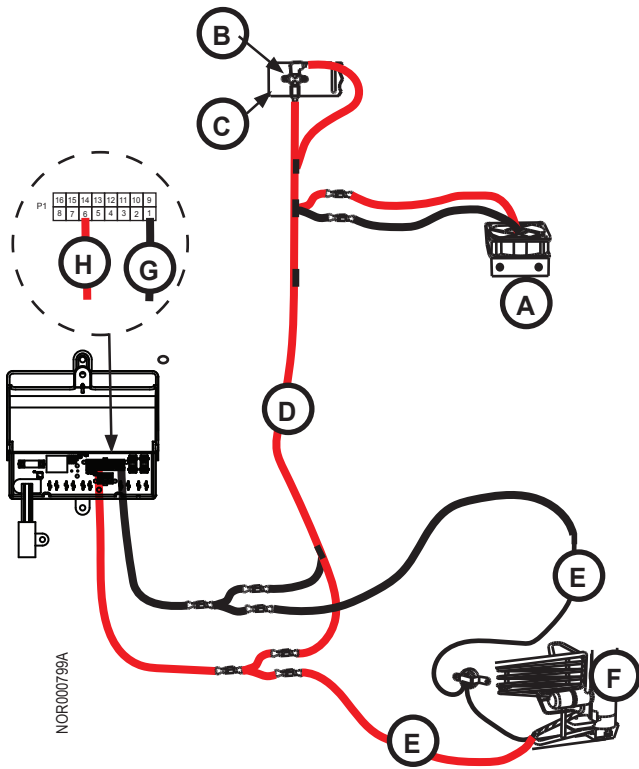

Fig. 20 - Fan and cold weather heater wiring

A	Fan / Bracket Assembly
B	Fan Thermostat
C	Condenser
D	Auxiliary Wire Harness
E	Cold Weather Heater
F	Cooling Unit
G	P1-1 Auxiliary 12 VDC (ground)
H	P1-6 Auxiliary 12 VDC (positive)

### Ice Maker Only

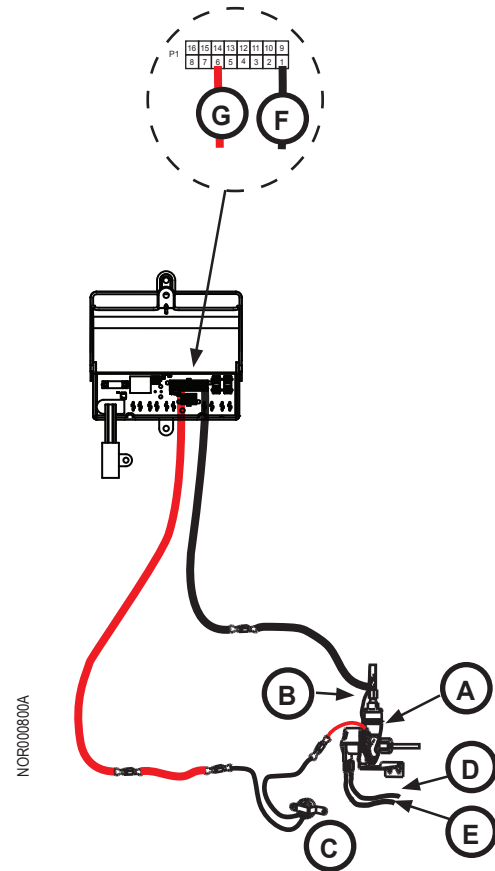

Fig. 21 - Ice maker only wiring

A	Water Valve
B	Water Valve / IM Water Line Heater
C	Water Valve / IM Water Line Heater Thermostat
D	White from Power Cord
E	Brown from Ice Maker
F	P1-1 Auxiliary 12 VDC (ground)
G	P1-6 Auxiliary 12 VDC (positive)

### Ice Maker and Fan

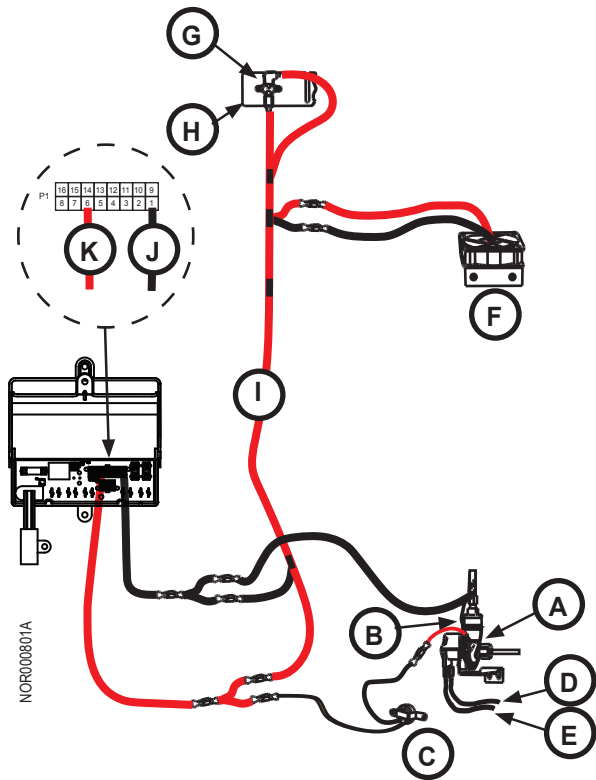

Fig. 22 - Ice maker and fan wiring

A	Water Valve
B	Water Valve / IM Water Line Heater
C	Water Valve / IM Water Line Heater Thermostat
D	White from Power Cord
E	Brown from Ice Maker
F	Fan / Bracket Assembly
G	Fan Thermostat
H	Condenser
I	Auxiliary Wire Harness
J	P1-1 Auxiliary 12 VDC (ground)
K	P1-6 Auxiliary 12 VDC (positive)

### Ice Maker, Fan, and Cold Weather Heater

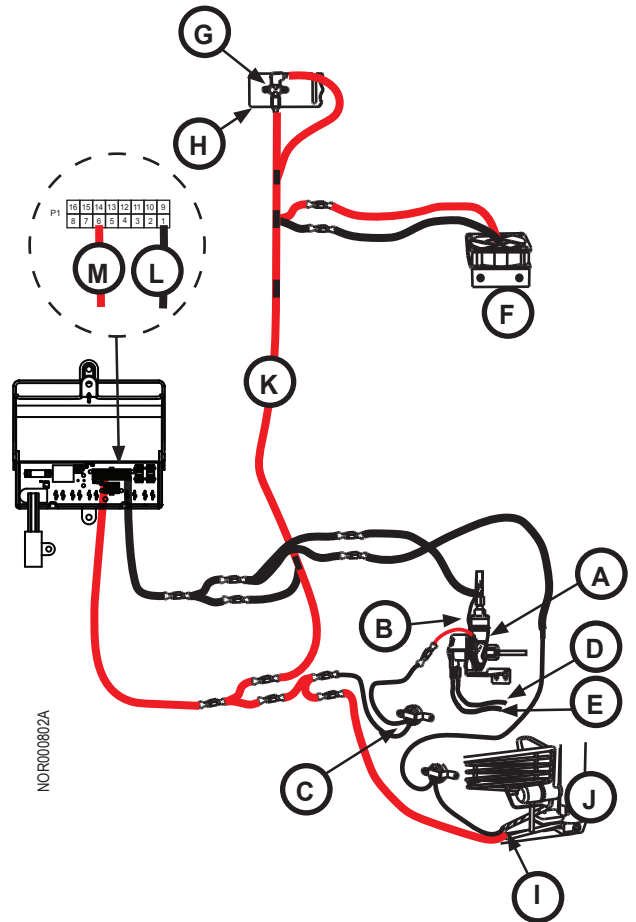

Fig. 23 - Ice maker, fan, and cold weather heater wiring

A	Water Valve
B	Water Valve / IM Water Line Heater
C	Water Valve / IM Water Line Heater Thermostat
D	White from Power Cord
E	Brown from Ice Maker
F	Fan / Bracket Assembly
G	Fan Thermostat
H	Condenser
I	Cold Weather Heater
J	Cooling Unit
K	Auxiliary Wire Harness
L	P1-1 Auxiliary 12 VDC (ground)
M	P1-6 Auxiliary 12 VDC (positive)

# ICE MAKER

For information about ice maker operation and troubleshooting, please refer to the separate Ice Maker Service document.

## REMOVE / REPLACE THE REFRIGERATOR

### **CAUTION**

The rear of the refrigerator has sharp corners. To prevent cuts or abrasions when working on the refrigerator, be careful and wear cut resistant gloves.

### Remove the Refrigerator

1. Close the valve at the propane gas tanks(s) of the vehicle.

### **WARNING**

To avoid possible propane gas leaks, always use two (2) wrenches to loosen and tighten the propane gas supply lines at the refrigerator's manual shut off valve.

2. Open the lower intake vent and remove the propane gas supply line from the 3/8 inch male flare fitting of the refrigerator.
3. Unplug the AC power cord from the receptacle.
4. Remove the DC wiring from the battery or the converter of the vehicle.
5. Put a mark on the DC wires so that you can put them back in the correct location.
6. Remove the DC wires from the refrigerator.
7. Remove the screws which fasten the rear mounting flange of the refrigerator to the floor.
8. Remove the plastic plugs from the lower plastic trim of the refrigerator.
9. Remove the screws that go through the lower plastic trim, the lower mounting bracket, and into the floor.
10. Remove the upper plastic trim by pulling it off of the upper mounting bracket.
11. Remove the screws in the upper mounting bracket which fasten the refrigerator to the wall.

### **WARNING**

Very heavy object. Do not attempt to remove without help. Unassisted attempts will likely cause bodily injury, property damage, or both.

12. Remove the refrigerator from the opening.

### Replace the Refrigerator

### **WARNING**

Very heavy object. Do not attempt to install without help. Unassisted attempts will likely cause bodily injury, property damage, or both.

1. Push the refrigerator completely into the enclosure.

### **WARNING**

Make sure the combustion seal is not broken, is completely around the refrigerator mounting flanges, and is between the mounting flanges and the wall of the enclosure. If the combustion seal is not complete, exhaust fumes can be present in the living area of the vehicle. The breathing of exhaust fumes can cause dizziness, nausea, and in extreme cases, death.

2. Put the screws through the upper mounting bracket and into the wall.
3. Push the upper trim plastic trim onto the upper mounting bracket.
4. Push the lower plastic trim onto the lower mounting bracket.
5. Put two screws through the lower plastic trim, the lower mounting bracket, and into the floor.
6. Open the lower intake vent and put the screws through the rear mounting flange of the refrigerator into the floor.
7. Connect the DC wires from the refrigerator.
8. Connect the DC wiring to the battery or the converter.
9. Push the AC power cord into the receptacle.

### **WARNING**

To avoid possible propane gas leaks, always use two (2) wrenches to loosen and tighten the propane gas supply lines at the refrigerator's manual shut off valve.

10. Attach the propane gas supply line to the 3/8 inch male flare fitting of the refrigerator.

### Conduct Leak Test

1. Open the valve of the propane gas tank(s) of the vehicle.

### **WARNING**

Do not allow the leak checking solution to touch the electrical components. Many liquids are electrically conductive and can cause a shock hazard, electrical shorts, and in some cases, fire.

### **WARNING**

Do not use any leak test solution that contains ammonia or chlorine. Ammonia and chlorine corrode brass and copper components.

2. Using a leak checking solution, examine the gas supply line connections for leaks. No leaks are allowed.